

Axiom™ AN by StoneL

Installation, maintenance and
operating instructions



Table of contents

1 General	3
1.1 Introduction	3
1.2 Title plate markings	3
1.3 CE markings	3
1.4 Recycling and disposal	3
1.5 Safety precautions	3
1.6 Assembly drawing	4
1.7 Specifications for all models	4
1.8 Pneumatic valve specifications	5
1.9 Pneumatic valve schematics	5
1.10 Dimensions	6
2 Assembly and mounting	7
2.1 Instructions	7
2.2 Axiom AN assembly figure	8
3 Maintenance, repair and installation	9
3.1 Maintenance and repair	9
3.2 Installation	9
3.3 Specific conditions of use	9
4 Function specific details	10
4.1 Sensor/switching modules	10
4.1.1 SST N.O. sensor (35S & 35W)	10
4.1.2 NAMUR sensor (45S) single coil	12
4.1.2 NAMUR sensor (45S) dual coil	13
4.2 Valve communication terminals (VCT)	16
4.2.1 VCT with DeviceNet™ communication (92S & 92W)	16
4.2.2 VCT with AS-Interface communication (96S)	18
4.2.3 VCT with AS-Interface communication and extended addressing (97S & 97W)	20
5 Wireless Link user guide	22
5.1 Getting started	22
5.2 Home screen	22
5.3 Locked screen	22
5.4 Device detail screen	23
5.5 More information screen	24
5.6 Diagnostics screen	24
5.7 Federal Communication Commission (FCC) and Industrial Canada (IC) statements	25
5.7.1 Federal Communication Commission (FCC)	25
5.7.2 Industrial Canada (IC)	25
6 Model/Type code	26
7 Regulatory, specific conditions of use, and product marking	27
8 Appendix	29
8.1 Controlled installation drawings	29

Read these instructions first!

These instructions provide information about safe handling and operation of the Axiom AN by StoneL. If you require additional assistance, please contact the manufacturer or manufacturer's representative. Addresses and phone numbers are printed on the back cover.

Save these instructions.

Subject to change without notice.

All trademarks are property of their respective owners.

1 General

1.1 Introduction

This manual incorporates the Installation, Maintenance and Operation (IMO) instructions for the Axiom AN series valve controllers. The Axiom AN is designed to provide position feedback indication and pneumatic control of on/off automated valves.

Note

The selection and use of the Axiom AN in a specific application requires close consideration of detailed aspects. Due to the nature of the product, this manual cannot cover all the likely situations that may occur when installing, using, or servicing the Axiom AN. If you are uncertain about the use of this device, or its suitability for your intended use, please contact Stonel for assistance.

1.2 Title plate markings

The limit switch has an identification plate attached to the cover.

1. Identification plate markings:
2. Model
3. Serial number
4. Date
5. Electrical rating(s)
6. Protection class information*
7. Note
8. Warning
9. Approval markings*
10. Logo

Note

* See page 27 for specific product markings.

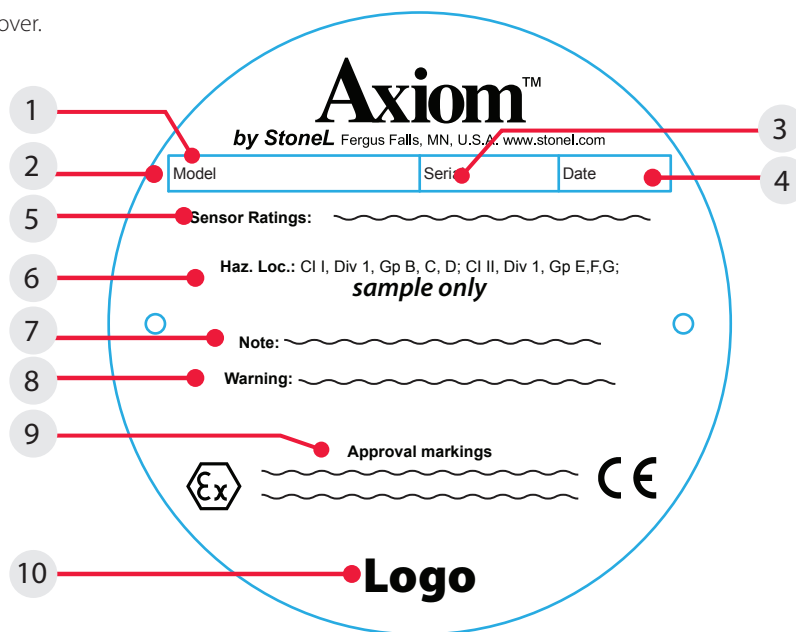

1.3 CE markings

The limit switch meets the requirements of European Directives and has been marked according to the directive.

1.4 Recycling and disposal

Most limit switch parts can be recycled if sorted according to material. In addition, separate recycling and disposal instructions are available from us. A limit switch can also be returned to us for recycling and disposal for a fee.

1.5 Safety precautions

Do not exceed the permitted values! Exceeding the permitted values marked on the limit switch may cause damage to the switch and to equipment attached to the switch and could lead to uncontrolled pressure release in the worst case. Damage to the equipment and personal injury may result.

To prevent ignition of hazardous atmospheres, replace cover before energizing the electrical circuits. Keep cover tightly closed when in operation.

1.6 Assembly drawing

- | | |
|--|--|
| 1. Title plate | 10. Visual indicator drum |
| 2. Cover | 11. Visual indicator drum coupler |
| 3. Body screws | 12. Visual indicator drive block |
| 4. Internal ground lug | 13. DA/SR plug |
| 5. External ground lug | 14. Air manifold plate mounting screws |
| 6. Body | 15. Air manifold plate orifice o-rings |
| 7. Visual indicator cover | 16. Air manifold plate |
| 8. Trigger | 17. Actuator shaft |
| 9. Visual indicator drum retaining screw | |

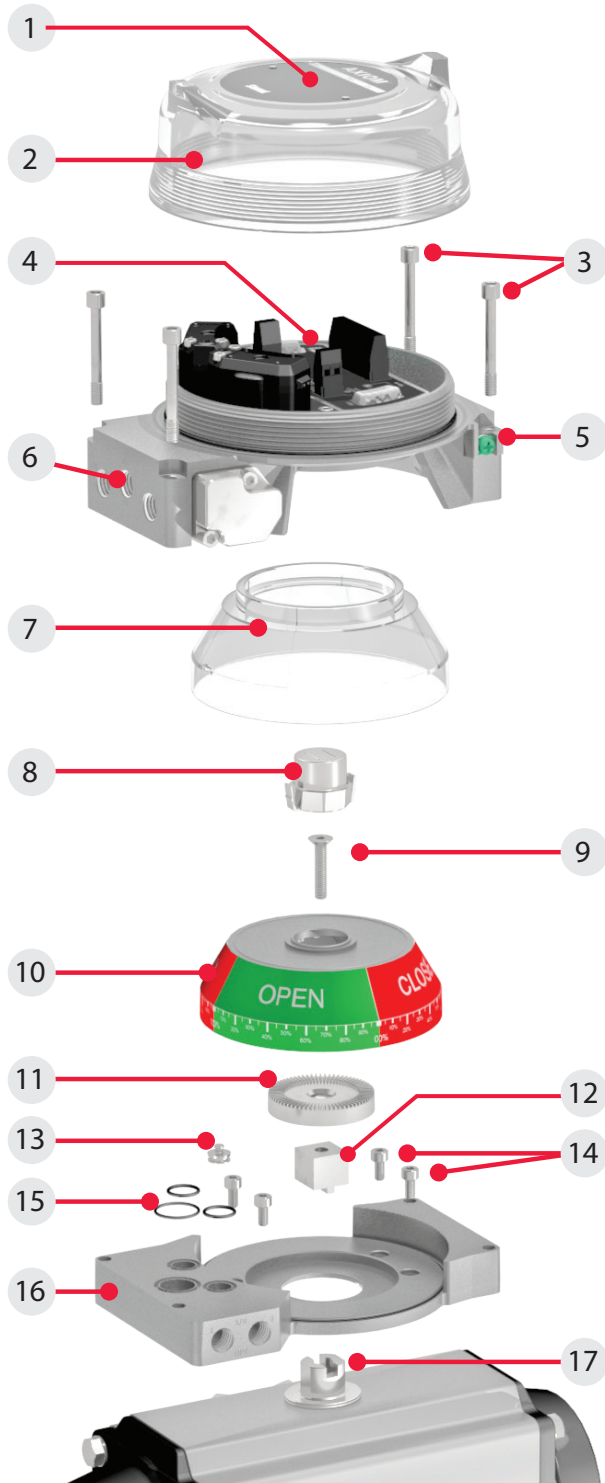

1.7 Specifications for all models

See page 10 for function specific details.

Specifications	
Materials of construction	
Housing & air manifold plate	Epoxy-coated anodized aluminum
Visual indicator drum	Nylon
Visual indicator cover	Polycarbonate
Fasteners	Stainless steel
O-rings	Nitrile compound
Operating life	1 million cycles (0.8 Cv) 500,000 cycles (1.2 Cv)
Temperature range	-40° C to 80° C (-40° F to 176° F)
Enclosure protection	Type 4, 4X, and 6 and IP66 / IP67
Warranty	
Sensing & communication module	Five years
Mechanical components	Five years
Unit weights	
Aluminum	2.38 kg / 5.25 lb
Unit dimensions	
Unit height	122.00 mm [4.80 in]
Cover removal clearance	214.00 mm [8.40 in]
Position sensing	
Accuracy	Within 1°
Repeatability	Within 1°
Setting buffer	4° from set point (<i>Rotational distance from original set point where switch will energize on return stroke</i>)
Dead band	6° from set point (<i>Rotational distance from original set point where switch will de-energize</i>)
Max rotational range	120°
Terminal block specifications	
Recommended torque	4.42 in.lbs (0.5 Nm)
Conductor strip length	0.22 -0.25 in (5.5-6.5 mm)
Maximum wire size	30-12 AWG (0.5-2.5 mm ²)
Wire type	Stranded or solid
Environmental conditions	
Location	Indoor and outdoor
Maximum altitude	5000 m
Maximum humidity	90%
Pollution degree	4
Ratings and approvals*	See page 27 or www.stonel.com/approvals/

* Only models listed on Stonel's official website are approved per specific rating.

1.8 Pneumatic valve specifications

Specifications		
General pneumatic specifications		
Valve design	Pilot operated spool valve	
Configuration	Single pilot	5-way, 2-position, spring return
	Dual pilot	5-way, 2-position, shuttle piston
Flow rating	0.8 Cv (Kv = 0.69 based on flow m3/hr) 1.2 Cv (Kv = 1.04 based on flow m3/hr)	
Axiom porting	¼" NPT (0.8 Cv) ⅜" NPT (1.2 Cv)	
Manifold porting	¼" NPT	
Medium	Air or inert gas	
Medium temperature range (TS)	-40° C to 80° C	
Operating pressure	45 psi to 120 psi (3.1 to 8.2 bar)	
Operating temperature	-40° C to 80° C (-40° F to 176° F)	
Operating life	1 million cycles (0.8 Cv) 500,000 cycles (1.2 Cv)	
Manual override	Internal momentary Optional external momentary available Optional external latching available	
Material of construction		
Aluminum enclosure	Spool	Nickel plated aluminum
	Body	Epoxy coated anodized aluminum
	Seal spacers	Polysulfone
	Spool seals	Nitrile compound
	O-rings	Nitrile compound
	End caps and fasteners	316 stainless steel
Solenoid coil specifications		
35S, 35W		
Operating voltage	20 - 250 VAC 50/60 Hz; 20 - 55 VDC 20 - 60 VAC 50/60 Hz; 20 - 55 VDC (with connector option 18)	
Power consumption	12 mA @ 20 - 250 VAC (1.0 watt typical) 20 mA @ 20 - 55 VDC (0.5 watts typical)	
Inrush current	3.75 A @ 125 VAC (typical) 3.0 A @ 220 VAC (typical) 0.15 A @ 24 VDC (typical)	
Filtration requirements	50 microns	
45S (Intrinsically Safe)		
Operating voltage	18 - 28 VDC	
Power consumption	0.3 watts	
Filtration requirements	50 microns	
Entity parameters	Ui=28 VDC, li=120 mA, Ci=3 nF, Li=0 mH, Pi=0.84 W	
92S, 92W, 97S & 97W		
Operating voltage	24 VDC	
Power consumption	0.5 watts	
Filtration requirements	50 microns	

1.9 Pneumatic valve schematics

Fig. 1 Single pilot spring return pneumatic valve on spring return actuator with rebreather open

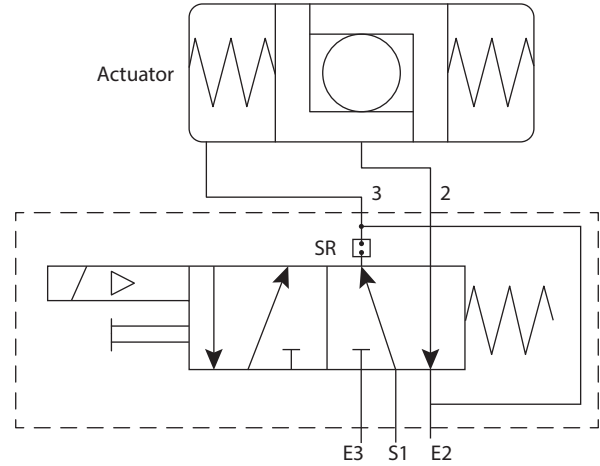

Fig. 2 Single pilot spring return pneumatic valve on double-acting actuator with rebreather closed

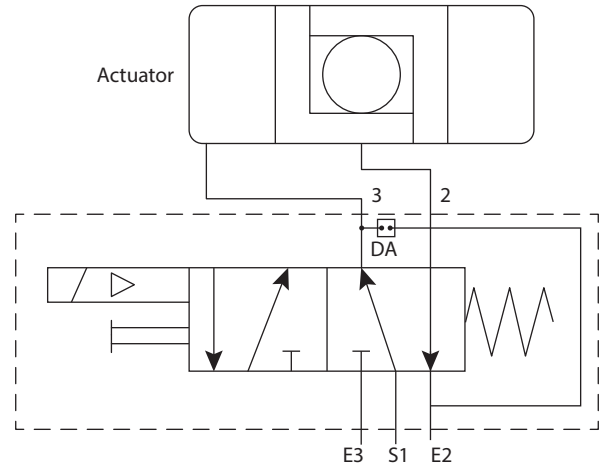
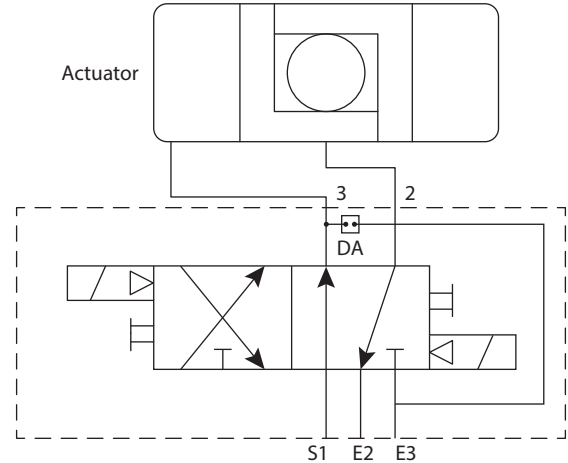
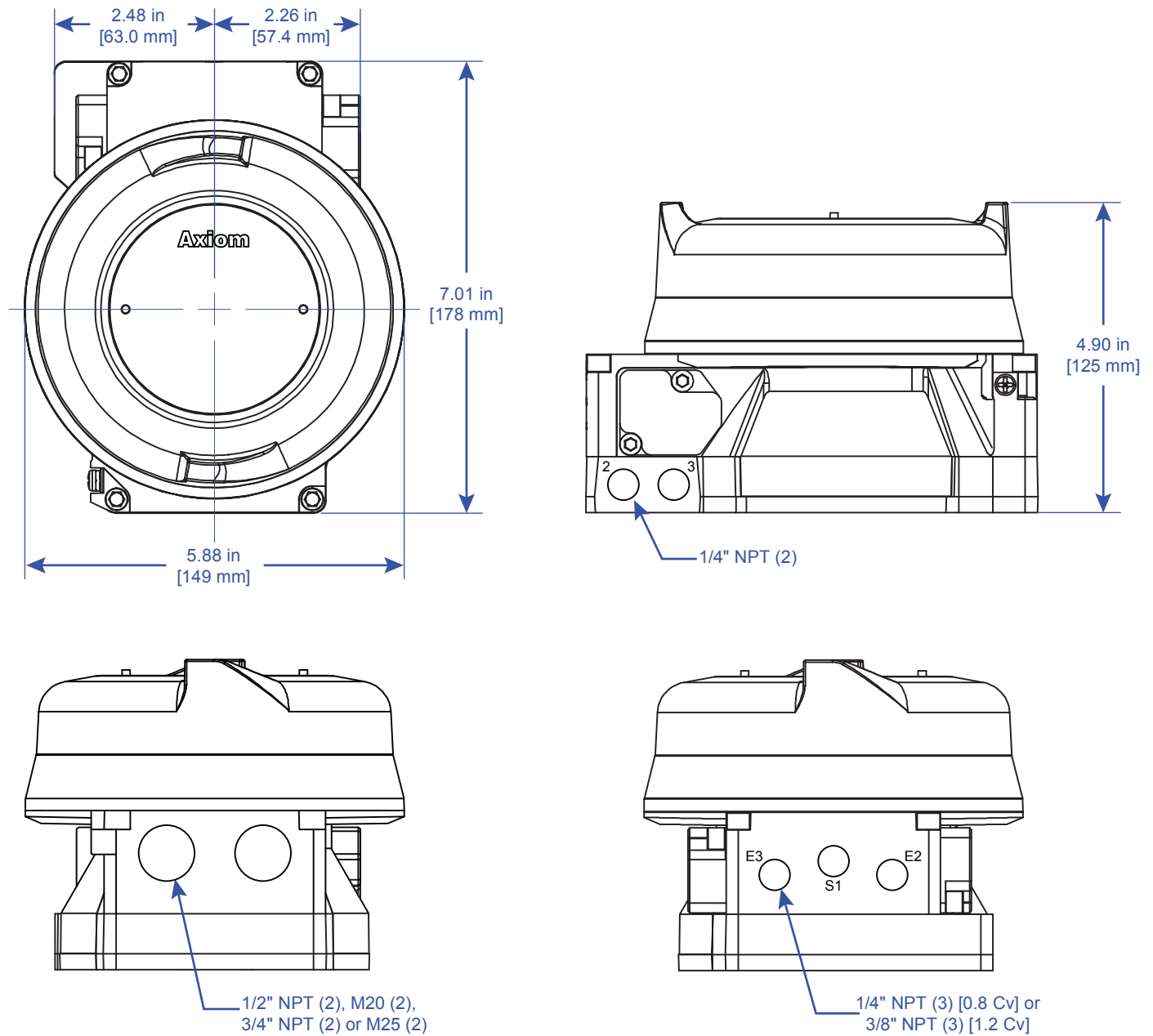

Fig. 3 Axiom dual coil shuttle piston pneumatic valve



1.10 Dimensions



Note

Axiom AN certified dimensional drawing can be found at www.stonel.com/

2 Assembly and mounting

2.1 Instructions

Special notes:

- Mounting of the Axiom requires a StoneL mounting kit specific to the actuator the Axiom is to be mounted to.
- It is recommended that thread lubricant or anti-seize be used on the Axiom body screws (Item C) prior to assembly.
- In high cycle or high vibration applications, blue Loctite® may be used on the air manifold mounting screws (Item I) and the visual indicator drum retaining screw (Item E).
- It is highly recommended that exhaust ports E2 and E3 be fitted with low restriction mufflers or breather vent caps to prevent ingestion of water and debris into the pneumatic valve.

Steps

Refer to Axiom AN assembly figure on page 8 when performing mounting and assembly procedures. Axiom unit and mounting kit are supplied separately. From Axiom shipping container, ensure items A, D, F and G are present. From the mounting kit, ensure items E, H, I, J, K, and K are present.

1. Determine if the actuator the Axiom is to be mounted on is double-acting (DA) or spring return (SR). Ensure the DA/SR plug (Item J) is in the corresponding port in the air manifold plate. (See detailed view of L below). If the DA/SR plug is in the incorrect position, gently remove it with a pair of pliers and insert into the proper orifice.
2. Locate the air manifold plate (Item L) and place on the actuator. Using an M4 allen wrench, fasten with the four air manifold mounting screws (Item I). Torque screws to 25 to 30 in.lbs (2.8 to 3.4 Nm).
3. Place visual indicator drive block (Item H) into slot in the actuator shaft. Place visual indicator drum coupler (Item G) onto the visual indicator drive block. Next, place the visual indicator drum (Item F) onto the visual indicator drum coupler. Align the holes in all three items with the threaded hole in the actuator shaft and fasten down with the visual indicator drum retaining screw (Item E). Leave screw loose in order to facilitate indexing of the visual indicator.
4. With the actuator in the closed position, center the visual indicator drum until the CLOSED quadrants are centered between the visual indicator cutouts on the air manifold plate. (See detailed view of K below). With an M4 allen wrench, tighten down with the visual indicator drum retaining screw. Torque screws to 15 to 20 in.lbs (1.7 to 2.3 Nm).
5. Place the trigger (Item D) into the visual indicator drum, aligning the locking tabs to the corresponding notches in the visual indicator drum. Press down on trigger until the locking tabs snap into place.
6. Verify air manifold plate orifice o-rings (Item J) are in place.
7. Set the Axiom body (Item A) in place. With an M5 allen wrench, torque the Axiom body screws (Item C) to 8 to 10 ft. lbs (10.8 to 13.5 Nm).
8. After all wiring and sensor setting procedures have been completed, install Axiom cover and tighten.

Detailed view of L

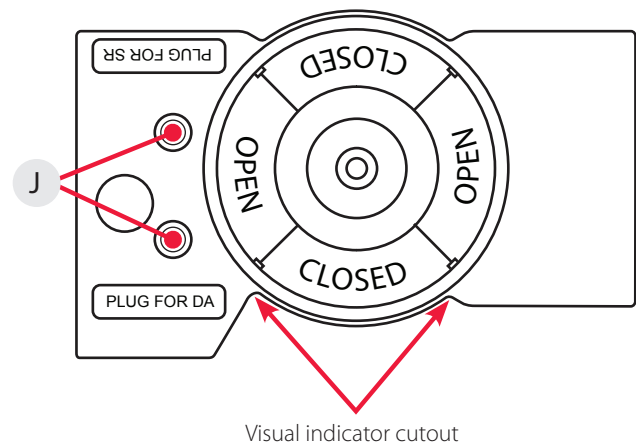

2.2 Axiom AN assembly figure

- A. Axiom AN unit
- B. External ground lug (Internal ground lug provided)
- C. Body screws (4)
- D. Trigger
- E. Visual indicator drum retaining screw
- F. Visual indicator drum
- G. Visual indicator drum coupler
- H. Visual indicator drive block
- I. Air manifold plate mounting screws
- J. DA/SR plug
- K. Air manifold plate orifice o-rings
- L. Air manifold plate

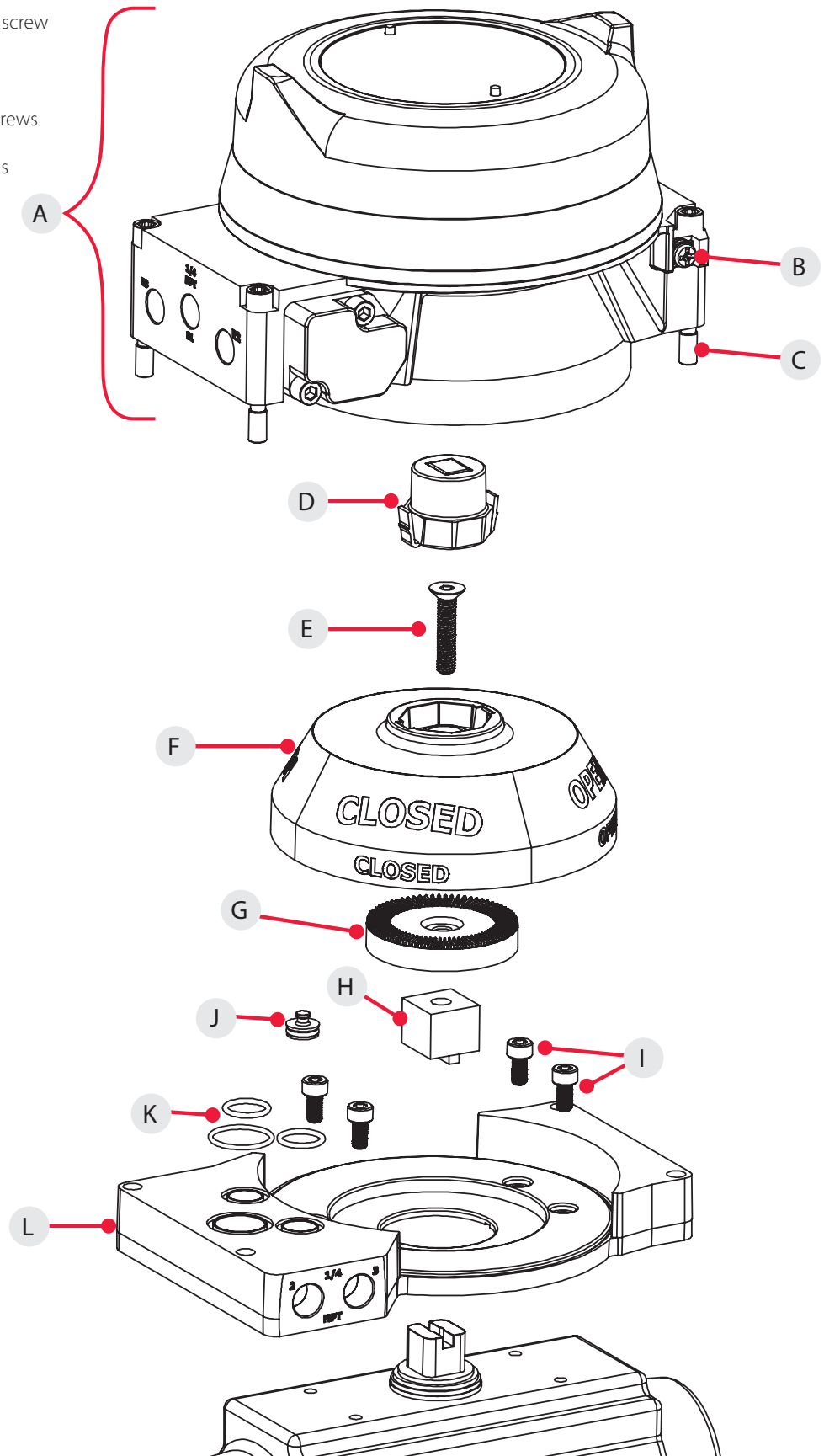

3 Maintenance, repair and installation

3.1 Maintenance and repair

No routine maintenance of Axiom units is required when installed in environments for which they are designed. If installed in severe environments, pneumatic components may require replacement at more frequent intervals for maximum performance. Repair of Axiom units must be done by StoneL or by qualified personnel that are knowledgeable about the installation of electromechanical equipment in hazardous areas. All parts needed for repair must be purchased through a StoneL authorized distributor to maintain warranty and to ensure the safety and compliance of the equipment.

3.2 Installation

WARNING

Solenoid power supplied must be limited with a fuse or circuit breaker rated to 2 Amps maximum.



Caution: To maintain safety, only power supplies that provide Double/Reinforced insulation, such as those with PELV/SELV outputs, shall be used. (As applicable)



Attention: If the unit is used in a manner not specified by StoneL, the protection provided by it may be impaired.



Attention: If required, the Axiom housing can be grounded to earth potential by either the internal or external ground lug. (See Assembly drawing 1.6 items 4 and 5 on page 4)



Attention: In order to maintain enclosure type and IP ratings, cover shall be tightened by hand a minimum of ¼ turn after cover engages o-ring. Do not use any tool to tighten the cover.

Field wiring

- It is the responsibility of the installer, or end user, to install this product in accordance with the National Electrical Code (NFPA 70) or any other national or regional code defining proper practices.
- This product comes shipped with conduit covers in an effort to protect the internal components from debris during shipment and handling. It is the responsibility of the receiving and/or installing personnel to provide appropriate permanent sealing devices to prevent the intrusion of debris or moisture when stored or installed outdoors.
- Use field wiring rated at least 10 K (+10° C) above ambient temperature.

3.3 Specific conditions of use

See Declaration of Conformity for specific conditions of use.

4 Function specific details

4.1 Sensor/switching modules

4.1.1 SST N.O. sensor (35S & 35W)

Specifications	
Configuration	(2) N.O. 2-wire solid state sensors
Voltage range	20 - 250 VAC 50/60 Hz; 20 - 125 VDC 20 - 60 VAC 50/60 Hz; 20 - 55 VDC (with connector option 18)
Minimum on current	2.0 mA
Maximum continuous current	0.1 amps
Maximum leakage current	0.50 mA (AN35S); 0.60 mA (AN35W)
Maximum voltage drop	6.5 volts @ 10 mA 7.2 volts @ 100 mA
Circuit protection	Protected against short circuits and direct application of voltage with no load.

Wiring diagrams

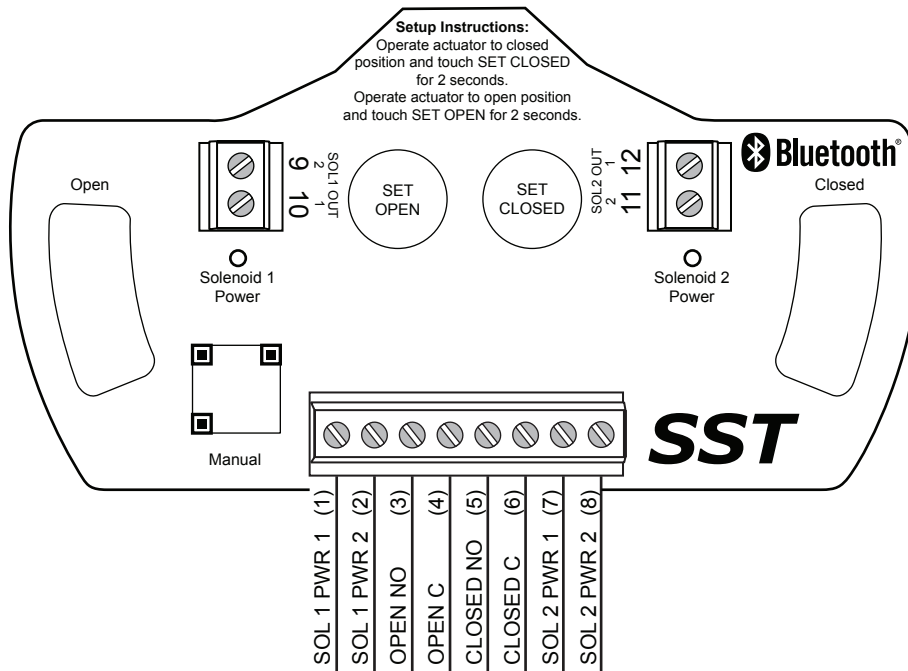

Common receptacle options pin-out for single coil unit

5-PIN MICRO CONNECTOR (M12)

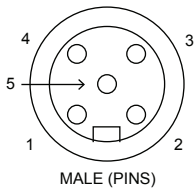

Pin	Signal
1	OPEN/CLOSED C
2	CLOSED NO
3	OPEN NO
4	SOL PWR IN +
5	SOL PWR IN -

5-PIN MINI CONNECTOR

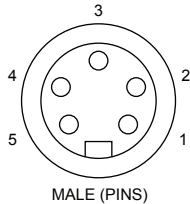

Common receptacle options pin-out for dual coil unit

6-PIN MICRO CONNECTOR (M12)

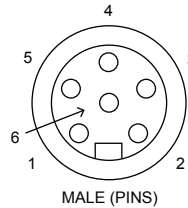

Pin	Signal
1	OPEN/CLOSED C
2	CLOSED NO
3	OPEN NO
4	SOL1 & SOL2 PWR IN
5	SOL1 PWR IN
6	SOL2 PWR IN

6-PIN MINI CONNECTOR

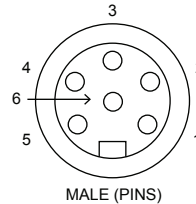

4.1.1 SST N.O. sensor (35S & 35W) continued

Bench test procedure and sensor setting instructions

Power must be applied to both sensors to ensure proper circuit operation. Use a 24 VDC power supply with series load resistor, (2K - 6K Ω), connected to the 24 VDC+.

1. Connect 24 VDC+ to the CLOSED C (common) and OPEN C (common) terminals. Connect 24 VDC- to the CLOSED NO and OPEN NO terminals.
 2. Operate actuator to the closed position.
 3. Press and hold SET CLOSED button until Closed LED is lit (2 seconds). Release button.
 4. Operate actuator to the open position.
 5. Press and hold SET OPEN button until Open LED is lit (2 seconds). Release button.
 6. Setpoints are retained even after power is removed.
- To electrically test solenoid, apply power to the SOL PWR IN terminals only.

Note

If using only one of the sensors for valve position feedback, the Closed sensor (red) must be used.



Wink feature

The Wink feature provides the capability of setting the closed or open LEDs to simultaneously flash or wink at a 2 Hz rate. This feature aids in physically locating the unit on the network. Does not change valve state indication in the control system.

Specifications for Wireless Link	
Communication	Bluetooth® technology; single mode (not compatible with Bluetooth® Classic)
Frequency band	2.402-2.480 Ghz
Transmit power	4dBm or ~2.5 milliwatts
Data rate	1 Mbit/second; effective information transmit rate ~10 Kbits/second
Range	Up to 100 meters (330 feet) in free space. Range is reduced by obstructions between handheld device and Wireless Link VCT. Line of site is not necessary.
Registrations	FCC, IC, CE
CE compliance	Exceeds industrial compliance standards
VCT identification	VCTs in range will be displayed in order of signal strength
VCT link	One device accessed at a time between client (handheld device) and server (VCT). Each server accessed by one client at a time
Application	StoneL Wireless Link available from the App store
Hand-helds	Compatible with iPhone® and iPad® with iOS 9 or later

4.1 Sensor/switching modules

4.1.2 NAMUR sensor (45S) single coil

Specifications		
Configuration	(2) NAMUR sensors (EN 60947-5-6; IS)	
Voltage range	5 - 25 VDC	
Current ratings	Target present	current < 1.0 mA
	Target absent	current > 2.1 mA
<i>Use with intrinsically safe repeater barrier. NAMUR sensors conform to EN 60947-5-6 standard.</i>		



Reference controlled installation drawing #105412 for proper intrinsic safe installation details. Find document in the Appendix on page 29.

Wiring diagrams

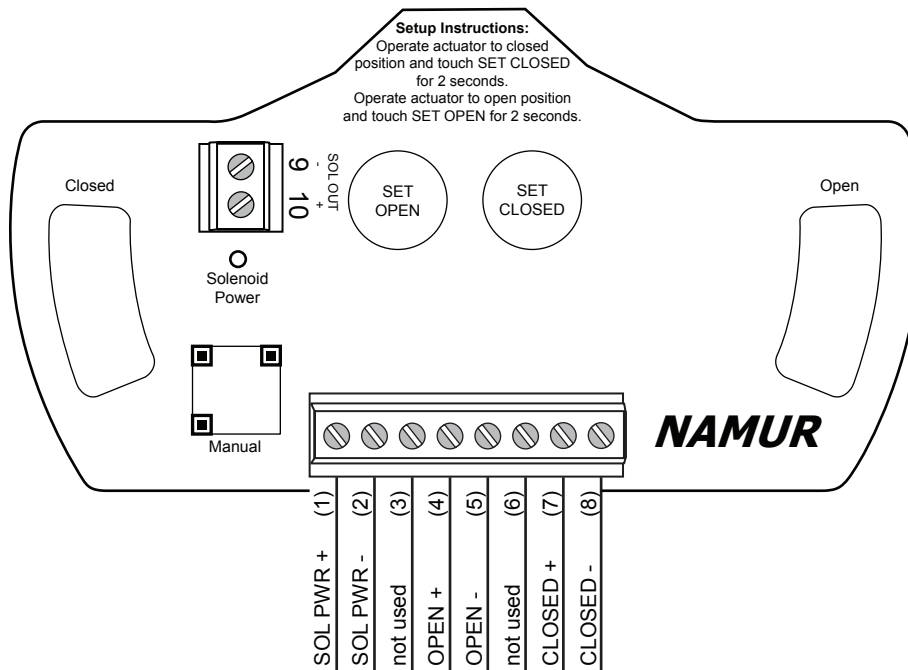

Common receptacle options pin-out for single coil unit

6-PIN MICRO CONNECTOR (M12)

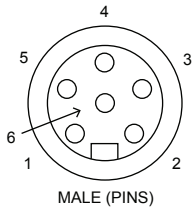

6-PIN MINI CONNECTOR

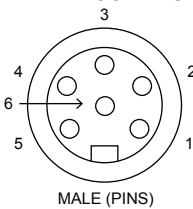

Pin	Signal
1	OPEN +
2	OPEN -
3	SOL PWR +
4	CLOSED +
5	CLOSED -
6	SOL PWR -

4.1.2 NAMUR sensor (45S) dual coil

Specifications		
Configuration	(2) NAMUR sensors (EN 60947-5-6; IS)	
Voltage range	5 - 25 VDC	
Current ratings	Target present	current < 1.0 mA
	Target absent	current > 2.1 mA
<i>Use with intrinsically safe repeater barrier. NAMUR sensors conform to EN 60947-5-6 standard.</i>		



Reference controlled installation drawing #105412 for proper intrinsic safe installation details. Find document in the Appendix on page 29.

Wiring diagrams

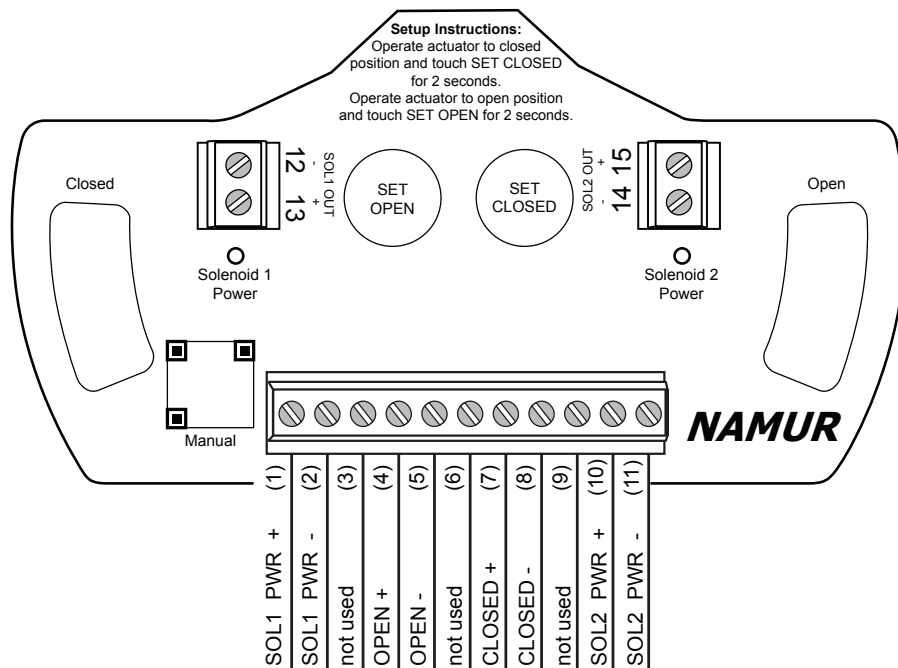

Common receptacle options pin-out for single coil unit

6-PIN MICRO CONNECTOR (M12)

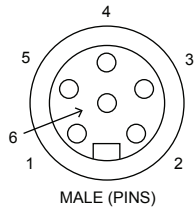

6-PIN MINI CONNECTOR

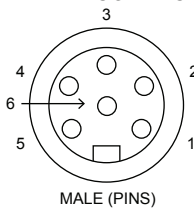

Pin	Signal
1	OPEN +
2	OPEN -
3	SOL PWR +
4	CLOSED +
5	CLOSED -
6	SOL PWR -

4.1.2 NAMUR sensor (45S) continued

Bench test procedure and sensor setting instructions

Power must be applied to both sensors to ensure proper circuit operation. Use a 24 VDC power supply. A series load resistor is not required when bench testing.

1. Connect 24 VDC+ to the CLOSED + and OPEN + terminals.
Connect 24 VDC- to the CLOSED - and OPEN - terminals.
2. Operate actuator to the closed position.
3. Press and hold SET CLOSED button until Closed LED is lit (2 seconds). Release button.
4. Operate actuator to the open position.
5. Press and hold SET OPEN button until Open LED is lit (2 seconds).
Release button. Both Open and Closed LEDs will be lit during mid-travel.
6. Setpoints are retained even after power is removed.

Note

If using only one of the sensors for valve position feedback, the Closed sensor must be used.

Typical basic intrinsically safe circuits

NAMUR sensor circuit

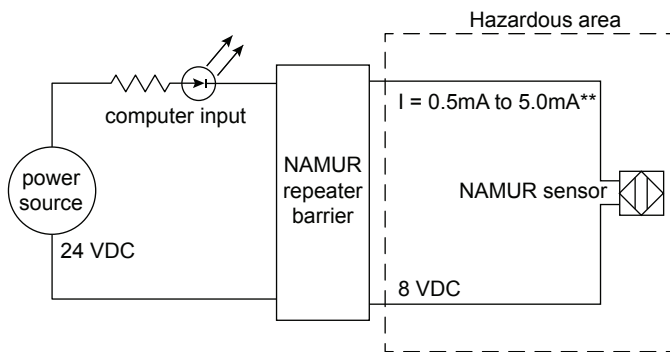

** Barrier off state (target off): current in NAMUR sensor circuit $>2.1\text{ mA}$
Barrier on state (target on): current in NAMUR sensor circuit $<1.0\text{ mA}$

Solenoid circuit

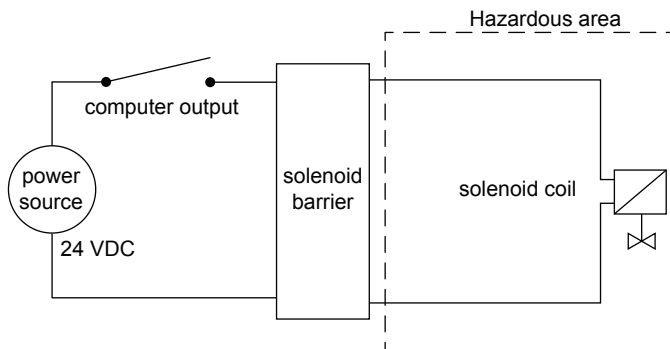

4.2 Valve communication terminals (VCT)

4.2.1 VCT with DeviceNet™ communication (92S & 92W)

Specifications	
Communication protocol	DeviceNet™
Configuration	(2) Discrete inputs (sensors) (1) Auxiliary analog input (4-20 mA) (2) Discrete outputs (solenoids)
Input voltage	11 - 25 VDC via DeviceNet™ network
Output voltage	24 VDC
Analog input impedance	254 ohms
Quiescent current	No analog input, no outputs energized: 35 mA @ 24 VDC; 57 mA @ 11 VDC
Current consumption (coil energized)	56 mA @ 24 VDC
Maximum output current	150 mA (all outputs combined)
Default address	63 (software assigned)
Default baud rate	125K (software selectable 125K, 250K or 500K baud)
Messaging	Polling, cyclic and change of state
DeviceNet™ type	100
Bit mapping	
Inputs (3 bytes)	Outputs (1 byte)
Byte 0, bit 0 = red LED / valve closed	Byte 0, bit 0 = solenoid 1
Byte 0, bit 1 = green LED / valve open	Byte 0, bit 1 = solenoid 2
Byte 0, bit 7 = fault bit	Byte 0, bit 2 = wink
Byte 1, bits 8-15 = 4-20 mA analog input	Byte 0, bit 3 = remote set closed
Byte 2, bits 16-23 = 4-20 mA analog input (4-20 mA analog input 0-10,000 scaling)	Byte 0, bit 4 = remote set open
	Byte 0, bit 7 = wireless link enabled

Common receptacle options pin-out

5-PIN MICRO CONNECTOR (M12)

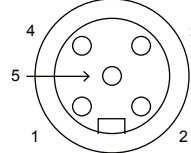

MALE (PINS)

5-PIN MINI CONNECTOR

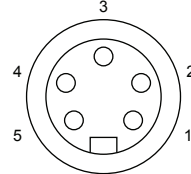

MALE (PINS)

Pin	Signal
1	Shield
2	V +
3	V -
4	CAN H
5	CAN L

Wiring diagrams

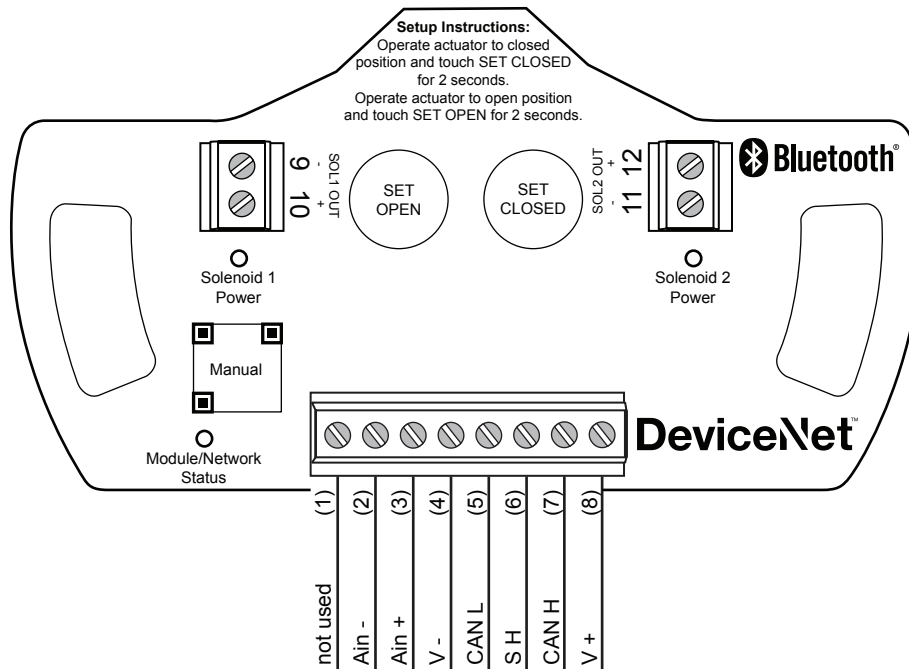

4.2.1 VCT with DeviceNet™ communication (92S & 92W) continued

WARNING

Do not apply external power to the output terminals. This will cause permanent damage to the unit.

 **Attention:** Any external auxiliary device connected to the VCT module shall be ground isolated.

Bench test procedure and sensor setting instructions

To test sensors, use a 24 VDC power supply. No series load resistor is required.

1. Apply power across the V+ and V- terminal points.
2. Operate actuator to the closed position.
3. Press and hold SET CLOSED button until red LED is lit (2 seconds). Release button.
4. Operate actuator to the open position.
5. Press and hold SET OPEN button until green LED is lit (2 seconds). Release button.
6. Setpoints are retained even after power is removed.

A functioning DeviceNet™ network is required to test communications and solenoids.

Module/Network Status LED status	
DeviceNet™ status LED	Fault description
LED off	Device not powered, or is alone on the bus
Solid green	Device is online and allocated to a master
Flashing green	Device is online, but not allocated to a master
Flashing red (Minor Fault)	Output shorted
Flashing red (Minor Fault)	No magnet detected
Flashing red (Minor Fault)	Communication to protocol controller has failed
Flashing red (Minor Fault)	Connection to DeviceNet™ master has timed-out
Flashing red (Minor Fault)	Address/baud switches are not equal to currently online values
Solid red (Major Fault)	Internal sensor fault - sensor may need replacing
Solid red (Major Fault)	Device has detected another device on the bus with the same DeviceNet™ address
Solid red (Major Fault)	Device has detected a CAN network Bus-off fault

 **Caution:** Power cycling unit with Byte 0, Bit 3 or Bit 4 set will cause the sensor(s) to set at that valve position. Ensure Byte 0, Bit 3 and Bit 4 are reset to 0 after performing a remote sensor setting.

Remote sensor setting feature

The Remote Sensor Setting feature provides the capability of setting the closed and open sensors remotely from the control system.

1. DeviceNet™ communications are required in order to remotely set the sensors. The unit must be addressed and correctly configured to be recognized by the control system.
2. With the valve/actuator in the closed position, set byte 0, bit 3 to "1" for at least two seconds. This will set the closed sensor to that valve/actuator position. Set byte 0, bit 3 back to "0"
3. With the valve/actuator in the open position, set Byte 0, Bit 4 to "1" for at least two seconds. This will set the open sensor to that valve/actuator position. Set byte 0, bit 4 back to "0"

Wink feature

The Wink feature provides the capability of setting the closed or open LEDs to simultaneously flash or wink at a 2 Hz rate. This feature aids in physically locating the unit on the network.

1. DeviceNet™ communications are required in order to set the Wink feature. The unit must be addressed and correctly configured to be recognized by the control system.
2. Set byte 0, bit 2 to "1" in the desired unit. Once the correct unit has been physically located on the network, indicated by the winking of the LEDs, set byte 0 bit 2 back to "0". Performing this function will not change the closed and open sensor setpoints.

Fault Bit (input byte 0, bit 7)

The Fault Bit will set to a 1 when input byte 0, bits 0 and 1 are set to 1 or 0 at the same time.

When input byte 0, bits 0 and 1 are both set to 1, this would indicate that the valve is both open and closed at the same time. This would be an abnormal or Fault condition.

Specifications for Wireless Link	
Communication	Bluetooth® technology; single mode (not compatible with Bluetooth® Classic)
Frequency band	2.402-2.480 Ghz
Transmit power	4dBm or ~2.5 milliwatts
Data rate	1 Mbit/second; effective information transmit rate ~10 Kbits/second
Range	Up to 100 meters (330 feet) in free space. Range is reduced by obstructions between handheld device and Wireless Link VCT. Line of site is not necessary.
Registrations	FCC, IC, CE
CE compliance	Exceeds industrial compliance standards
VCT identification	VCTs in range will be displayed in order of signal strength
VCT link	One device accessed at a time between client (handheld device) and server (VCT). Each server accessed by one client at a time
Application	StoneL Wireless Link available from the App store
Hand-helds	Compatible with iPhone® and iPad® with IOS 9 or later

4.2 Valve communication terminals (VCT)

4.2.2 VCT with AS-Interface communication (96S)

Specifications	
Communication protocol	AS-Interface v3.0
Configuration	(2) Discrete inputs (sensors) (2) Auxiliary discrete inputs (2) Discrete outputs (solenoid)
Input voltage	26.5-31.6 VDC (AS-I voltage)
Output voltage	24 VDC (+/- 10%)
Quiescent current	35 mA
Current consumption (coil energized)	56 mA
Maximum output current	100 mA (all outputs combined)
Default address	00
ID/IO codes	ID = F; IO = 4; ID1 = F; ID2 = E (S-4.F.E.)
Bit assignment	
Inputs	Outputs
Bit 0 = aux input 1	Bit 0 = not used
Bit 1 = aux input 2	Bit 1 = not used
Bit 2 = green LED / valve open	Bit 2 = OUT 1
Bit 3 = red LED / valve closed	Bit 3 = OUT 2

Common receptacle options pin-out

4-PIN MICRO CONNECTOR (M12)

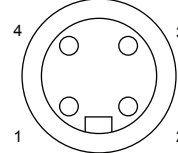

MALE (PINS)

4-PIN MINI CONNECTOR

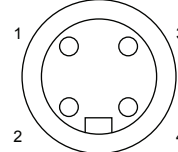

MALE (PINS)

Pin	Signal
1	ASi +
2	not used
3	ASi -
4	not used

Wiring diagram

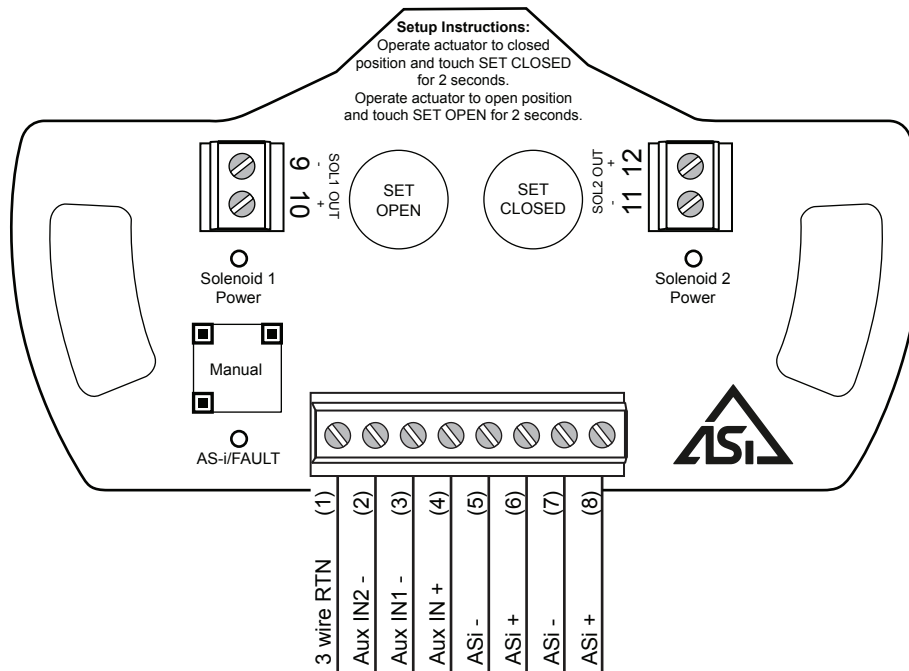

4.2.2 VCT with AS-Interface communication and extended addressing (96S) continued

WARNING

Do not apply external power to the output terminals. This will cause permanent damage to the unit.

Bench test procedure and sensor setting instructions

To test sensors, use a 24 VDC power supply. No series load resistor is required.

1. Apply power across the ASi+ and ASi- terminal points.
2. Operate actuator to the closed position.
3. Press and hold SET CLOSED button until red LED is lit (2 seconds).
Release button.
4. Operate actuator to the open position.
5. Press and hold SET OPEN button until green LED is lit (2 seconds).
Release button.
6. Setpoints are retained even after power is removed.

A functioning AS-Interface network is required to test communications.

Power/Fault LED status

AS-i status LED	Fault description
LED off	Device does not have power
Solid green	Normal operation
Flashing red/green	Output shorted
Flashing red/green	No magnet detected
Flashing red/green	Internal sensor fault - sensor may need replacing
Flashing yellow/red	No data exchange (device address = 0)
Solid red	No data exchange

4.2 Valve communication terminals (VCT)

4.2.3 VCT with AS-Interface communication and extended addressing (97S & 97W)

Specifications		
Communication protocol	AS-Interface v3.0	
Configuration	(2) Discrete inputs (sensors) (2) Auxiliary discrete inputs (2) Discrete outputs (solenoid)	
Input voltage	26.5-31.6 VDC (AS-I voltage)	
Output voltage	24 VDC (+/- 10%)	
Quiescent current	35 mA	
Current consumption (coil energized)	56 mA	
Maximum output current	100 mA (all outputs combined)	
Default address	0A	
ID/IO codes	ID = A; IO = 7; ID1 = F; ID2 = E (S-7.A.E.)	
Bit assignment	Outputs	Parameter
Inputs	Bit 0 = OUT 1	Bit 0 = wink
Bit 0 = red LED / valve closed	Bit 1 = OUT 2	Bit 1-3 = not used
Bit 1 = green LED / valve open	Bit 2 = wireless link enabled	
Bit 2 = aux input 1	Bit 3 = not available	
Bit 3 = aux input 2		

Common receptacle options pin-out

4-PIN MICRO CONNECTOR (M12)

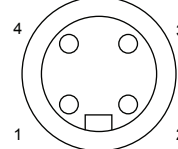

MALE (PINS)

4-PIN MINI CONNECTOR

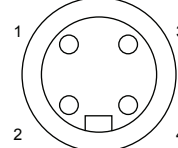

MALE (PINS)

Pin	Signal
1	ASi +
2	not used
3	ASi -
4	not used

Wiring diagram

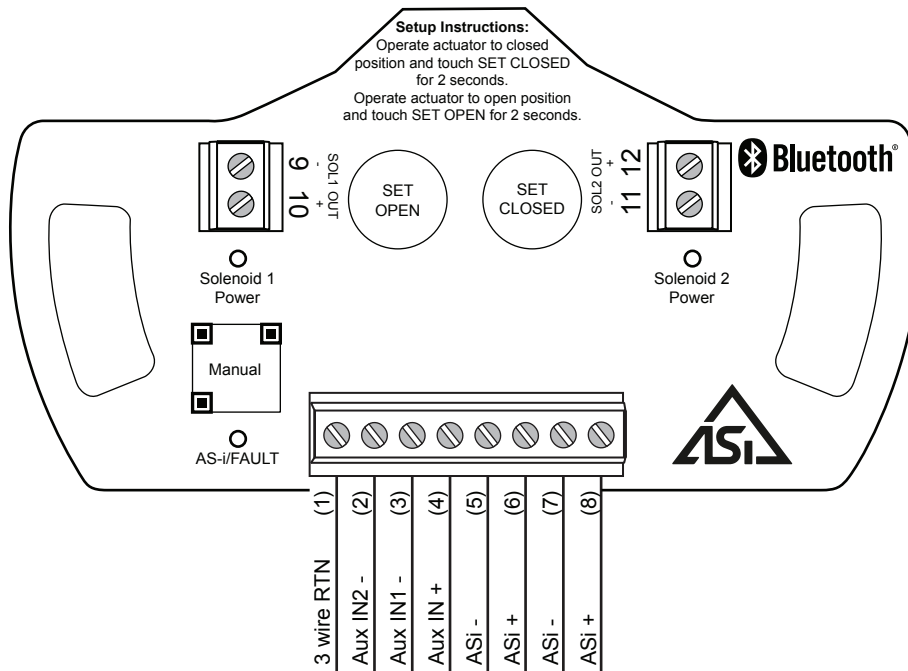

4.2.3 VCT with AS-Interface communication and extended addressing (97S & 97W) continued

WARNING

Do not apply external power to the output terminals. This will cause permanent damage to the unit.

Bench test procedure and sensor setting instructions

To test sensors, use a 24 VDC power supply. No series load resistor is required.

1. Apply power across the ASi+ and ASi- terminal points.
2. Operate actuator to the closed position.
3. Press and hold SET CLOSED button until red LED is lit (2 seconds). Release button.
4. Operate actuator to the open position.
5. Press and hold SET OPEN button until green LED is lit (2 seconds). Release button.
6. Setpoints are retained even after power is removed.

A functioning AS-Interface network is required to test communications.

Power/Fault LED status

AS-i status LED	Fault description
LED off	Device does not have power
Solid green	Normal operation
Flashing red/green	Output shorted
Flashing red/green	No magnet detected
Flashing red/green	Internal sensor fault - sensor may need replacing
Flashing yellow/red	No data exchange (device address = 0)
Solid red	No data exchange

Specifications for Wireless Link

Communication	Bluetooth® technology; single mode (not compatible with Bluetooth® Classic)
Frequency band	2.402-2.480 Ghz
Transmit power	4dBm or ~2.5 milliwatts
Data rate	1 Mbit/second; effective information transmit rate ~10 Kbits/second
Range	Up to 100 meters (330 feet) in free space. Range is reduced by obstructions between handheld device and Wireless Link VCT. Line of site is not necessary.
Registrations	FCC, IC, CE
CE compliance	Exceeds industrial compliance standards
VCT identification	VCTs in range will be displayed in order of signal strength
VCT link	One device accessed at a time between client (handheld device) and server (VCT). Each server accessed by one client at a time
Application	StoneL Wireless Link available from the App store
Hand-helds	Compatible with iPhone® and iPad® with IOS 9 or later

5 Wireless Link user guide

5.1 Getting started

Before using this guide, ensure that you have downloaded the most current version of the StoneL Wireless Link app to your iPhone® or iPad® from the App Store. It is an iPhone® app but designed to work with an iPad® as well. When searching the App Store on an iPad®, ensure that the drop-down menu at the top of search results page is set to "iPhone Only." Your iOS device must be running IOS 9 or later and be equipped with *Bluetooth*® technology to use the StoneL Wireless Link app. The app is not compatible with *Bluetooth*® Classic.

Make sure that your iOS device has its *Bluetooth*® capability turned on when attempting to use the StoneL Wireless Link app. This can be found under your iOS device's settings. To ensure that you have good *Bluetooth*® reception, keep your iOS device within 33 ft [10 m] of the module that you wish to connect to. The range of your *Bluetooth*® device may be affected by many things, including interference from other devices and physical obstructions.

WARNING

Upon disconnect or master disabling overrides, output forces will be removed and valve may cycle.

5.2 Home screen

Selecting a valve

After opening the StoneL Wireless Link app, you are directed to the home screen. This screen allows you to browse and select a specific automated valve when multiple valves are present.

1. All energized wireless modules within range of your iOS device will appear on the screen (Image 1). If no powered devices are within range, the device list will be blank.
2. To identify a specific valve when multiple valves are present, select the wink button next to the unit you wish to select (Item A). This will cause the module's LEDs to blink for 30 seconds, or until you press the "Stop Winking" button (Item B)
3. Choose a specific valve by selecting the row that relates to the unit you wish to select (Item C), this will direct you to the device detail screen.

Note

The list of devices present can be refreshed by swiping downward on the home screen.

Releasing a device

Once you have selected a device, it will be paired to your Apple device until you unpair it.

1. In order for another Apple device user to access control with their wireless link app, unpair your device by going back to the home screen/device list.

Menu

Selecting the menu (Item D) on the upper left corner of the home screen allows you access import and export features (Image 2).

1. The device list import allows you to import: valve tag number, device address, baud rate (if applicable), valve/actuator description and additional information from a CSV file.
2. The device list export allows you to export: valve tag number, device address, baud rate (if applicable), valve/actuator description, valve position, stroke time, cycle count data, and additional information to a CSV file.

5.3 Locked screen

If the icons on the device detail screen appear grayed-out or unavailable to select, this means the master is still in control. (Image 3) Check to ensure that the power supply is set to IR addressing mode (AS-i only) or enable the control override bit for the device (AS-i DO Bit 2; DeviceNet™ Byte 0, Bit 7).

Image 1



Image 2



Image 3

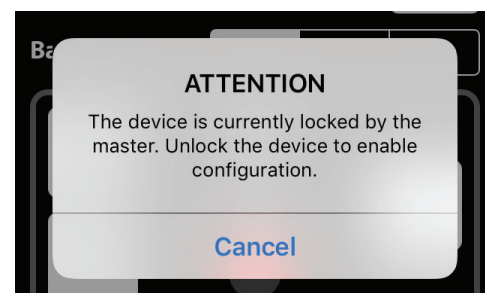

5.4 Device detail screen

You can customize the tag for a device, change the address, change the baud rate (if applicable), force the solenoids on or off, cause the device to wink, and set the open/closed limits from the device detail screen (Image 4a or 4b).

Changing the device tag or address on a DeviceNet unit

- To change the tag, edit the existing tag in the associated text field (Item E). The tag can be up to sixteen characters long.
- To change the DeviceNet address, edit the existing address in the associated text field (Item G). The DeviceNet address for the 92W can be 1 to 63
 - When changing the address, a warning screen will appear indicating this action could disrupt the process. Select cancel or continue.
 - Select continue and alter the address via number pad and select done. A warning screen will appear indicating the choice to reset now or reset later. Resetting the device could disrupt the process.
 - Selecting reset now will implement the address change of the device.
 - Selecting reset later will not implement device address change until selecting reset slave (Item F) and will cause the device address to indicate pending status.
- To change the device baud rate (Item H), select the desired rate from the choices. The device default baud rate is 125K.
 - When changing the baud rate, a warning screen will appear indicating this action could disrupt the process. Select reset now or reset later.
 - Selecting reset now will implement the change to the baud rate of the device.
 - Selecting reset later will not implement the change to the baud rate of the device until selecting reset slave.
- Selecting reset slave will cause a warning screen to appear indicating resetting the device could disrupt the process. Select continue to implement changes made to the device address and/or device baud rate.

Changing the device tag or address on an ASi unit

- To change the tag, edit the existing tag in the associated text field (Item M). The tag can be up to sixteen characters long.
- To change the AS-i address, edit the existing address in the associated text field (Item N). The AS-i address for the 97W can be 0A to 31A or 0B to 31B.
 - When changing the address, a warning screen will appear indicating this action could disrupt the process. Select cancel or continue.
 - Select continue and alter the address via number pad and select done.

Forcing the solenoids on/off

Forcing a solenoid on or off will override master control if wireless link overrides are enabled.

- The solenoid control state is forced on or forced off when it is highlighted in orange (Item J).
 - Warning screen will appear indicating this action could disrupt the process. Select cancel or continue.
 - Select continue and when a solenoid is on, a yellow light will illuminate next to the solenoid (Item K).
 - Select continue and when a solenoid is off, no light will illuminate next to the solenoid (Item L).

Image 4a - DeviceNet detail

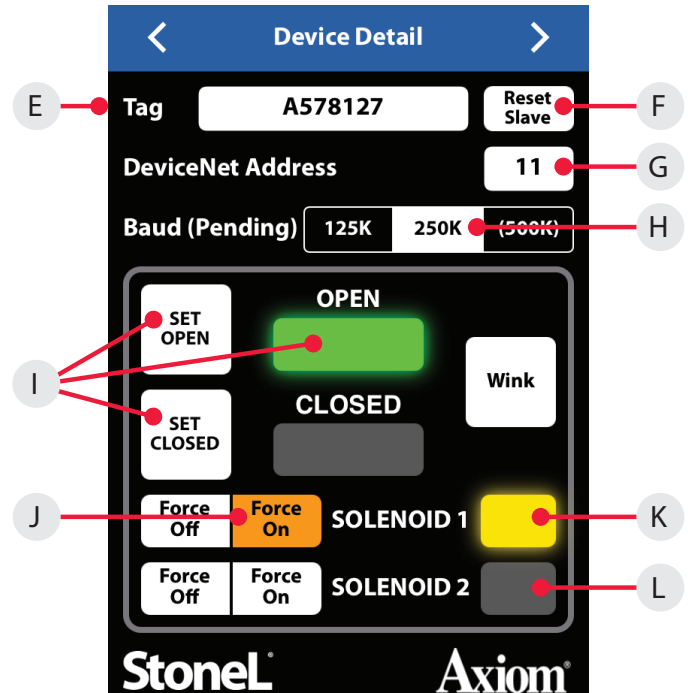
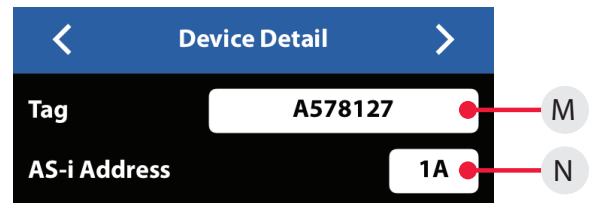

Image 4b - ASi detail



Setting the valve position

Forcing the solenoid on and off is one way of actuating the valve when setting the open and closed positions.

- To set a valve to the closed position:
 - Actuate the valve to the CLOSED position. This can be done by forcing the solenoid(s) on or off.
 - Select set closed. A warning screen will appear indicating this action could disrupt the process. Select cancel or continue.
 - Select continue and the red closed light will illuminate (Item I).
 - The valve now remembers the current position as the closed position.
- To set a valve to the open position:
 - Actuate the valve to the OPEN position. This can be done by forcing the solenoid(s) on or off.
 - Select set open. A warning screen will appear indicating this action could disrupt the process. Select cancel or continue.
 - Select continue and the green open light will illuminate (Item I).
 - The valve now remembers the current position as the open position.

5.5 More information screen

To see additional information about a specific valve, swipe right or use the arrows at the top of the device detail screen.

- At the top of the more Information screen (Image 5), the unit model number, serial number, and date code are displayed (Item O). These are preset from the factory and cannot be changed.
- There are two customizable text boxes titled "Valve/Actuator Description" and "Additional Information" where up to 160 characters can be added for user notes, such as maintenance or service records (Item P).

Website and instruction manual

The direct links to Stonel's website and the unit Installation, Maintenance and Operating Instructions located on the bottom buttons of the More Information screen require an internet connection to access (Item Q).

5.6 Diagnostics screen

To see additional diagnostics about a specific valve, advance a page to the right using the arrows at the top of the more information screen.

- The valve position information includes real time valve position, stroke time baseline, and stroke time of last cycle (Item R).
- The valve cycle count is displayed and indicates how many cycles the valve has made since last reset (Item S). A cycle is considered to be a complete actuation of the valve. Selecting the reset button (Item U) will erase the cycle count and start counting again from 0.
- The current temperature of the valve monitor is displayed; along with the temperature range of the valve since last reset (Item T). Selecting the reset button (Item V) will erase the historical temperature data and start a new period of temperature data collection.
- If an external 4-20mA loop powered device is connected to the auxiliary analog input of the module, the feedback signal can be monitored here. (DeviceNet only - Item W)
- If external switches are connected to the Aux 1 or Aux 2 inputs of the module, these switches can be monitored here. (AS-i only - Item Y)
- The Error Status register (Item X) can display numerous faults that are detected by the module. This data is only available via the Wireless Link app and is not accessible from the bus network. The following is a list of errors/faults that can be detected and display on the iOS device:

Error status register		
Common	DeviceNet only	ASi only
Output shorted	Major DeviceNet fault	No data exchange
Internal sensor fault	Minor DeviceNet fault	
No magnet detected	DeviceNet timed-out	
Bus protocol error	Pending DeviceNet change	
	Duplicate address	
	Bus-off fault	

Image 5

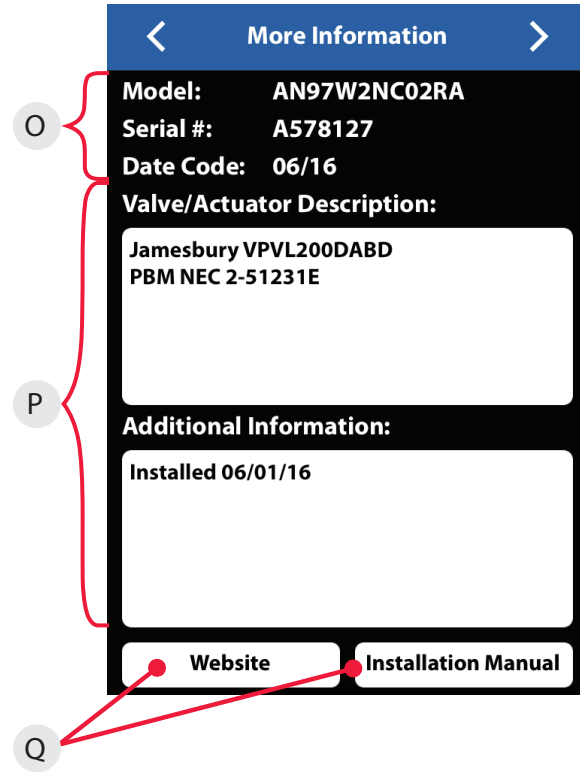

Image 6a - DeviceNet detail

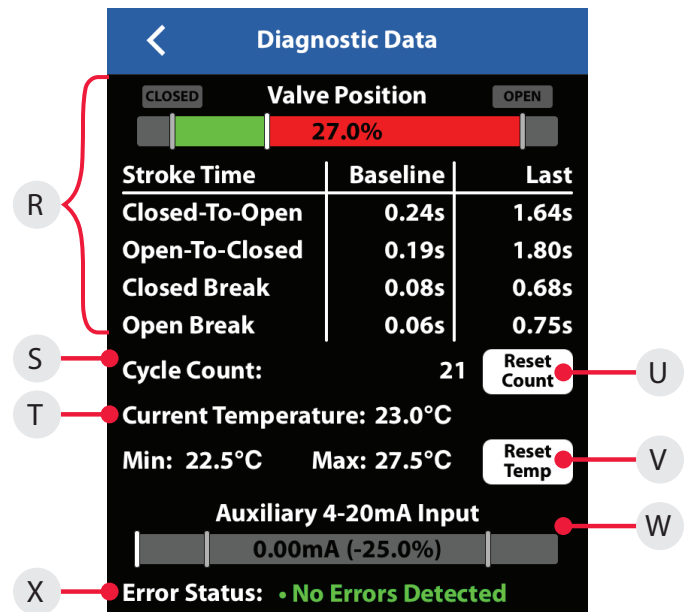
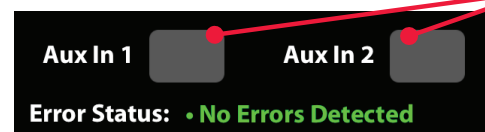

Image 6b - ASi detail



5.7 Federal Communication Commission (FCC) and Industrial Canada (IC) statements

5.7.1 Federal Communication Commission (FCC)

This device complies with Part 15 of the FCC Rules. Operation is subject to the following two conditions:

1. This device may not cause harmful interference.
2. This device must accept any interference received, including interference that may cause undesired operation.

Note

This equipment has been tested and found to comply with the limits for a Class A digital device, pursuant to part 15 of the FCC Rules. These limits are designed to provide reasonable protection against harmful interference when the equipment is operated in a commercial environment. This equipment generates, uses, and can radiate radio frequency energy and, if not installed and used in accordance with the instruction manual, may cause harmful interference to radio communications. Operation of this equipment in a residential area is likely to cause harmful interference in which case the user will be required to correct the interference at his own expense.

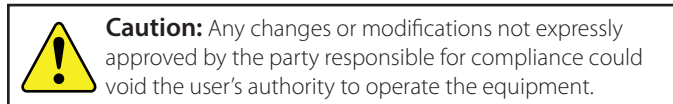

AN/ANX 35W: Contains FCC ID: SQGBL651

AN/ANX 92W, AN/ANX 96W, AN/ANX 97W: Contains FCC ID PI4BL600

FCC Radiation Exposure Statement

The product complies with the US portable RF exposure limit set forth for an uncontrolled environment and are safe for intended operation as described in this manual. The further RF exposure reduction can be achieved if the product can be kept as far as possible from the user body or set the device to lower output power if such function is available.

This transmitter must not be co-located or operating in conjunction with any other antenna or transmitter.

5.7.2 Industrial Canada (IC)

This device complies with Industry Canada's license-exempt RSSs. Operation is subject to the following two conditions:

1. This device may not cause interference; and
2. This device must accept any interference, including interference that may cause undesired operation of the device.

Le présent appareil est conforme aux CNR d'Industrie Canada applicables aux appareils radio exempts de licence. L'exploitation est autorisée aux deux conditions suivantes:

1. l'appareil ne doit pas produire de brouillage;
2. l'utilisateur de l'appareil doit accepter tout brouillage radioélectrique subi, même si le brouillage est susceptible d'en compromettre le fonctionnement.

AN/ANX 35W: Contains IC: 3147A-BL651

AN/ANX 92W, AN/ANX 96W, AN/ANX 97W: Contains IC: 1931B-BL600

Radiation Exposure Statement

The product complies with the Canada portable RF exposure limit set forth for an uncontrolled environment and are safe for intended operation as described in this manual. The further RF exposure reduction can be achieved if the product can be kept as far as possible from the user body or set the device to lower output power if such function is available.

Déclaration d'exposition aux radiations

Le produit est conforme aux limites d'exposition pour les appareils portables RF pour les Etats-Unis et le Canada établies pour un environnement non contrôlé. Le produit est sûr pour un fonctionnement tel que décrit dans ce manuel. La réduction aux expositions RF peut être augmentée si l'appareil peut être conserve aussi loin que possible du corps de l'utilisateur ou que le dispositif est réglé sur la puissance de sortie la plus faible si une telle fonction est disponible.

6 Model/Type code

Model selector

SERIES

AN Nonincendive or intrinsically safe

FUNCTIONS

Sensor/switching modules		Valve communication Terminals (VCTs)	
35S	SST Universal; 20 - 250 volt (NO sensor)	92S	DeviceNet™
35W	SST Universal; 20 - 250 volt (NO sensor) with Wireless Link	92W	DeviceNet™ with Wireless Link
45S	NAMUR module (EN 60947-5-6; I.S.)	96S	AS-Interface
		97S	AS-Interface with extended addressing
		97W	AS-Interface with extended addressing and Wireless Link

PNEUMATIC VALVE

1 Single pilot
 2 Dual pilot
 9 No solenoid

PNEUMATIC OVERRIDE

N Internal momentary override only / 0.8 Cv
 M External momentary & internal override / 0.8 Cv
 L External latching & internal override / 0.8 Cv
 E Internal momentary override only / 1.2 Cv
 Y External momentary & internal override / 1.2 Cv
 G External latching & internal override / 1.2 Cv
 X Special

ENCLOSURE

Clear cover		Aluminum cover	
C	North American (NEC/CEC)	A	North American (NEC/CEC)
D	International (IEC)	V	International (IEC)
B	Brazil	G	Brazil
F	China	H	China
N	Russian	R	Russian

CONDUIT/CONNECTORS

Standard	Mini-connectors	Micro-connectors (M12)
02 (2) ½" NPT	10 (1) 4-pin	13 (1) 4-pin
05 (2) M20	11 (1) 5-pin	15 (1) 5-pin
08 (2) ¾" NPT	19 (1) 6-pin	17 (1) 6-pin
09 (2) M25	20 (1) 7-pin	18 (1) 8-pin [60 VAC max]
	21 (1) 8-pin	

VISUAL INDICATOR

G Green Closed/Red Open
 R Red Closed/Green Open
 1 Three-way 1
 2 Three-way 2
 X Special

BRANDING

A StoneL
 M Neles

Model number example
 AN 35S 1 L C 02 R A OPTIONAL

MODEL NUMBER

PARTNERSHIP ID

Mounting hardware required and sold separately. Some models may include 5-digit identification suffix.

7 Regulatory, specific conditions of use, and product marking



DECLARATION OF CONFORMITY

Manufacturer:

Neles USA Inc, dba StoneL
26271 US Highway 59
Fergus Falls, Minnesota 56537 USA

Products:

Axiom AN Series – Valve Position Monitors and Valve Communication Terminals
Axiom ANX Series – Valve Position Monitors and Valve Communication Terminals

Model - Type	Certificates / Directives / Standards	Marking
AN Series ANX Series	EU Type Examination Certificate FM18ATEX0063X ATEX 2014/34/EU EN IEC 60079-0:2018, EN 60079-11:2012 EMC 2014/30/EU EN 60947-5-2:2007/A1:2012	 2809 ATEX II 1 G Ex ia IIC T5 Ga ATEX II 1 G Ex ia IIC T6 Ga
AN Series ANX Series	IECEX Certificate of Conformity IECEX FMG 18.0023X IEC 60079-0:2017, IEC60079-11:2011	Ex ia IIC T5 Ga Ex ia IIC T6 Ga
ANX Series	EU Type Examination Certificate FM20ATEX00019X ATEX 2014/34/EU EN IEC 60079-0:2018, EN 60079-1:2014 EMC 2014/30/EU, LVD 2014/35/EU EN 60947-5-2:2007/A1:2012 EN 62026-2:2013, EN 62026-3:2009 RED 2014/53/EU EN 62026-2:2013, EN 62026-3:2009, EN 62311:2008, EN 62479:2010, EN 301 489-1 v2.2.0 (2017-03), EN 301 489-17 v3.2.0 (2017-03), EN 300 328 v2.2.2 (2019-07)	 2809 ATEX II 2 G Ex db IIC T5 Gb ATEX II 2 G Ex db IIC T6 Gb
ANX Series	IECEX Certificate of Conformity IECEX FMG 20.0024X IEC 60079-0:2017, IEC 60079-1:2014	Ex db IIC T5 Gb Ex db IIC T6 Gb
AN Series ANX Series	EMC 2014/30/EU, LVD 2014/35/EU EN 60947-5-2:2007/A1:2012 EN 62026-2:2013, EN 62026-3:2009 RED 2014/53/EU EN 62026-2:2013, EN 62026-3:2009, EN 62311:2008, EN 62479:2010, EN 301 489-1 v2.2.0 (2017-03), EN 301 489-17 v3.2.0 (2017-03), EN 300 328 v2.2.2 (2019-07)	

ATEX Notified Bodies for EU Type Examination Certificates:

FM Approvals Europe Ltd., Dublin, Ireland (Notified Body Number 2809)

Quality Assurance Certificates:

ISO 9001:2015.....TUV SUD America Inc.
QAN FM20ATEXQ0008.....FM Approvals (Notified Body Number 2809)
QAR GB/FME/QAR20.0004.....FM Approvals (Notified Body Number 2809)

We declare under our sole responsibility that the products, as described, are in conformity with the listed standards and directives.

Fergus Falls, 1st February 2021



Bryan Beckman, Quality Manager
Authorized Person of the Manufacturer

7 Regulatory, specific conditions of use, and product marking continued

SPECIFIC CONDITIONS OF USE / MARKING

For AN and ANX Series – FM18ATEX0063X	
Specific Conditions of Use - Notes	Marking
1. Part of the enclosure may be constructed from plastic. To prevent the risk of electrostatic sparking the plastic surface should only be cleaned with a damp cloth. 2. The apparatus enclosure may contain aluminum which is considered to constitute a potential risk of ignition by impact or friction. Care must be taken into account during installation and use to prevent impact or friction.	ATEX II 1 G Ex ia IIC T5 Ga Ta = -40°C to +80°C ATEX II 1 G Ex ia IIC T6 Ga Ta = -40°C to +65°C
For AN and ANX Series – IECEx FMG 18.0023X	
Specific Conditions of Use - Notes	Marking
1. Part of the enclosure may be constructed from plastic. To prevent the risk of electrostatic sparking the plastic surface should only be cleaned with a damp cloth. 2. The apparatus enclosure may contain aluminum which is considered to constitute a potential risk of ignition by impact or friction. Care must be taken into account during installation and use to prevent impact or friction.	Ex ia IIC T5 Ga Ta = -40°C to +80°C Ex ia IIC T6 Ga Ta = -40°C to +65°C
For AN Series – FM16US0468X / FM16CA0215X	
Specific Conditions of Use - Notes	Marking
AN45Sbcdefg-h. Valve Position Monitor 1. Part of the enclosure is constructed from plastic. To prevent the risk of electrostatic sparking the plastic surface should only be cleaned with a damp cloth. 2. The apparatus enclosure may contain aluminum which is considered to constitute a potential risk of ignition by impact or friction. Care must be taken into account during installation and use to prevent impact or friction. 3. The Turck minifast® and eurofast® male receptacles shall be mated with a Turck minifast® and eurofast® female cordset and the use of tool secured Turck lokfast® guard is required. ANabcdefg-h. Valve Position Monitor When e = Connector, 10, 11, 13, 15, 18, 19, 20, 21 or 22 The Turck minifast® and eurofast® male receptacles shall be mated with a Turck minifast® and eurofast® female cordset and the use of tool secured Turck lokfast® guard is required. NOTE: See also Control Drawing 105412 for "IS" installation.	NI / I, II, III / 2 / ABCDFG NI / 1 / 2 / ABCD I / 2 / IIC IS / I, II, III / 1 / ABCDEFG – 105412 IS / 1 / 1 / ABCD – 105412 I / 0 / AEx ia IIC T5 – 105412 I / 0 / Ex ia IIC T5 – 105412
For ANX Series – FM20ATEX00019X	
Specific Conditions of Use - Notes	Marking
1. To minimize the risk of electrostatic sparking, the equipment shall be cleaned only with a damp cloth. 2. Consult the manufacturer if dimensional information on the flameproof joints is necessary. 3. Applications in atmospheres containing Carbon Disulphide (CS ₂) is not permitted.	ATEX II 2 G Ex db IIC T5 Gb (Ta = -40°C to +80°C) ATEX II 2 G Ex db IIC T6 Gb (Ta = -40°C to +65°C)
For ANX Series – IECEx FMG 20.0024X	
Specific Conditions of Use - Notes	Marking
1. To minimize the risk of electrostatic sparking, the equipment shall be cleaned only with a damp cloth. 2. Consult the manufacturer if dimensional information on the flameproof joints is necessary. 3. Applications in atmospheres containing Carbon Disulphide (CS ₂) is not permitted.	Ex db IIC T5 Gb (Ta = -40°C to +80°C) Ex db IIC T6 Gb (Ta = -40°C to +65°C)
For ANX Series – FM20US0073X / FM20CA0035X	
Specific Conditions of Use - Notes	Marking
1. To minimize the risk of electrostatic sparking, the equipment shall be cleaned only with a damp cloth. 2. Consult the manufacturer if dimensional information on the flameproof joints is necessary. 3. Applications in atmospheres containing Carbon Disulphide (CS ₂) is not permitted.	US/Canada - XP/DIP: CL I, II, III, DIV 1, GP B,C,D,E,F,G T5 US/Canada - NI: CL I, II, III, DIV 2, GP A,B,C,D,F,G T5 US - CL I / Zone 1 / AEx db IIC T5 Gb US - CL I / Zone 2 / IIC / T5 Canada - Ex db IIC T5 Gb

8 Appendix

8.1 Controlled installation drawings

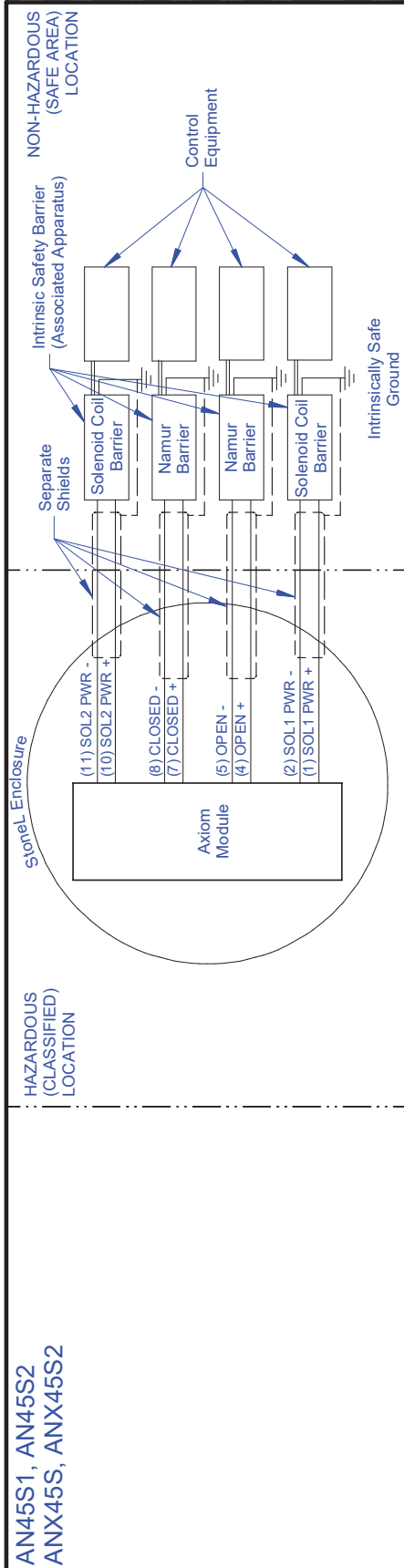

INSTALLATION NOTES:

(US - Class I, II, III, Division 1 & 2, Groups A, B, C, D, E, F, G, T5;
 Class I / Zone 0 / AEx ia IIC T5 Ga; Class II, III / Zone 20 / AEx ia IIIC T100°C Da)
 (Canada - Class I, II, III, Division 1 & 2, Groups A, B, C, D, E, F, G, T5;
 Class I / Zone 0 / Ex ia IIC T5 Ga; Class II, III / Zone 20 / Ex ia IIIC T100°C Da)

Entity Parameters:

Sensors: U_i (V_{max}) = 22 VDC; I_i (I_{max}) = 120 mA; P_i = 0.4 W; C_i = 3 nF; L_i = 0 H
Solenoid(s): U_i (V_{max}) = 28 VDC; I_i (I_{max}) = 120 mA; P_i = 0.84 W; C_i = 3 nF; L_i = 0 H

- The Associated Apparatus must be FM Approved.
- The Entity Concept allows interconnection of intrinsically safe apparatus with associated apparatus when the following is true: Voc, Vi or Uo < Ui (Vmax); Isc, It or Io < Ii (Imax); Ca > Ci + Ccable; La > Li + Lcable.
- Dust-tight conduit seal must be used when installed in Class II and Class III environments.
- Control equipment connected to barrier must not use or generate more than 250 Vrms or VDC.
- Installation should be in accordance with ANSI/ISA RPA1.2.06.01 "Installation of Intrinsically Safe Systems for Hazardous (Classified) Locations" and the National Electrical Code (ANSI/NFPA 70) or in accordance with the Canadian Electric Code.
- Associated apparatus manufacturer's installation drawing must be followed when installing this equipment.
- To maintain intrinsic safety, wiring associated with each sensor or solenoid coil wiring must be run in separate cables or separate shields connected to intrinsically safe (associated apparatus) ground.
- Conduit Grounding - Upon installation verify electrical continuity between conduit and ground terminal.
- Resistance between Intrinsic Safe Ground and earth ground must be less than one ohm.

Specific Conditions of Use:

- Part of the enclosure is constructed from plastic. To prevent the risk of electrostatic sparking the plastic surface should only be cleaned with a damp cloth.
- The apparatus enclosure may contain aluminum which is considered to constitute a potential risk of ignition by impact or friction. Care must be taken into account during installation and use to prevent impact or friction.
- For Division 2 installation the Turck minifast® and eurofast® male receptacles shall be mated with a Turck minifast and eurofast female cordset and the use of tool secured Turck lokfast® guard is required.

INSTALLATION NOTES (Ex ia IIC T6...T5 Ga; Ex ia IIIC T100°C Da):

Entity Parameters:

Sensors: U_i = 22 VDC; I_i = 120 mA; P_i = 0.4 W; C_i = 3 nF; L_i = 0 mH
Solenoid(s): U_i = 28 VDC; I_i = 120 mA; P_i = 0.84 W; C_i = 3 nF; L_i = 0 H

- Voc, Vi or Uo < Ui; Isc, It or Io < Ii; Ca > Ci + Ccable; La > Li + Lcable.
- Dust-tight conduit seal must be used when installed in Zone 20, Zone 21, and Zone 22 environments or where Ingress Protection of IP67 is required.
- Control equipment connected to barrier must not use or generate more than 250 Vrms or VDC.
- Installation should be in accordance with appropriate local code or practice.
- The configuration of associated apparatus for each sensor wiring pair or solenoid wiring pair must be approved.
- Associated apparatus manufacturer's installation drawing must be followed when installing this equipment.
- To maintain intrinsic safety, wiring associated with each sensor or solenoid coil wiring must be run in separate cables or separate shields connected to intrinsically safe (associated apparatus) ground.
- Conduit Grounding - Upon installation verify electrical continuity between conduit and ground terminal.
- Resistance between Intrinsic Safe Ground and earth ground must be less than one ohm.

Specific Conditions of Use:

- Part of the enclosure may be constructed from plastic. To prevent the risk of electrostatic sparking the plastic surface should only be cleaned with a damp cloth.
- The apparatus enclosure may contain aluminum which is considered to constitute a potential risk of ignition by impact or friction. Care must be taken into account during installation and use to prevent impact or friction.

REVISIONS		DATE		BY		DR.	
E	13982	06/16/20	RB	BL			
D	13940	09/11/18	RB	RB			
C	12685	04/10/17	RB	NK			
REVISION		ECO					

TOLERANCES (UNLESS OTHERWISE SPECIFIED):		SCALE		SHEET		DRAWING NO.	
X.XXX ± .005	ANGLES ± 0° 30'	NS	1 OF 3	A		105412	
X.XX ± .010	FINISH f 125 RMS	SIZE	DATE	1/14/2016		REV.	
X/X ± .015	DIMENSIONS: INCHES (UNLESS OTHERWISE SPECIFIED)	APPD.		NK		E	

RESTRICTED		Stonel™	
THIS DRAWING AND ALL INFORMATION CONTAINED HEREIN IS THE PROPERTY OF AND IS SUBJECT TO CHANGE BY STONEL. DRAWING IS NOT TO BE REPRODUCED OR REVEALED TO ANY OTHER PARTY UNLESS AUTHORIZED BY STONEL.		NEES USA, INC., FERGUS FALLS, MN 56337 USA	
TITLE: I.S. CONTROL, AXIOM, AN/ANX SERIES			

8.1 Controlled installation drawings continued

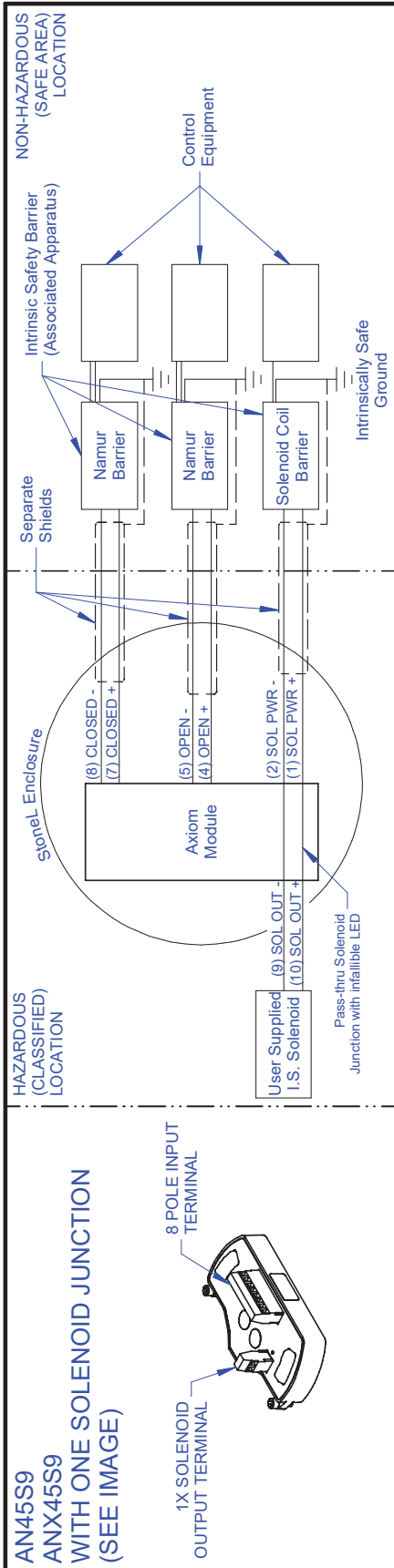

**AN45S9
ANX45S9
WITH ONE SOLENOID JUNCTION
(SEE IMAGE)**

HAZARDOUS (CLASSIFIED) LOCATION

NON-HAZARDOUS (SAFE AREA) LOCATION

INSTALLATION NOTES:
(US - Class I, II, III, Division 1 & 2, Groups A, B, C, D, E, F, G, T5;
Class I / Zone 0 / AEx ia IIC T5 Ga; Class II, III / Zone 20 / AEx ia IIC T100°C Da)
(Canada - Class I, II, III, Division 1 & 2, Groups A, B, C, D, E, F, G, T5;
Class I / Zone 0 / Ex ia IIC T5 Ga; Class II, III / Zone 20 / Ex ia IIC T100°C Da)

Entity Parameters:
Sensors: $U_i (V_{max}) = 22 \text{ VDC}$; $I_i (I_{max}) = 120 \text{ mA}$; $P_i = 0.4 \text{ W}$; $C_i = 3 \text{ nF}$; $L_i = 0 \text{ H}$
Solenoid Junction Terminals: $U_i (V_{max}) = 28 \text{ VDC}$; $I_i (I_{max}) = 120 \text{ mA}$; $C_i \text{ Junction}^* = 0$; $L_i \text{ Junction}^* = 0$
* Solenoid installation shall meet: $C_a \geq C_i \text{ solenoid} + C_i \text{ Junction} + C_{cable}$; $L_a \geq L_i \text{ solenoid} + L_i \text{ Junction} + L_{cable}$;

- The Associated Apparatus and I.S. solenoid must be FM Approved.
- The Entity Concept allows interconnection of intrinsically safe apparatus with associated apparatus when the following is true: V_{oc} , V_i or $U_o < U_i (V_{max})$; I_{sc} , I_i or $I_o < I_i (I_{max})$; $C_a > C_i + C_{cable}$; $L_a > L_i + L_{cable}$.
- Dust-tight conduit seal must be used when installed in Class II and Class III environments.
- Control equipment connected to barrier must not use of generate more than 250 Vrms or VDC.
- Installation should be in accordance with ANS/ISA RPA 12.06.01 "Installation of Intrinsically Safe Systems for Hazardous (Classified) Locations" and the National Electrical Code (ANSI/NFPA 70) or in accordance with the Canadian Electric Code.
- Associated apparatus manufacturer's installation drawing must be followed when installing this equipment.
- To maintain intrinsic safety, wiring associated with each sensor or solenoid coil wiring must be run in separate cables or separate shields connected to intrinsically safe (associated apparatus) ground.
- Conduit Grounding - Upon installation verify electrical continuity between conduit and ground terminal.
- Resistance between Intrinsic Safe Ground and earth ground must be less than one ohm.

Specific Conditions of Use:

- Part of the enclosure may be constructed from plastic. To prevent the risk of electrostatic sparking the plastic surface should only be cleaned with a damp cloth.
- The apparatus enclosure may contain aluminum which is considered to constitute a potential risk of ignition by impact or friction. Care must be taken into account during installation and use to prevent impact or friction.
- For Division 2 installation the Turck minifast® and eurofast® male receptacles shall be mated with a Turck minifast and eurofast female cordset and the use of tool secured Turck lokfast® guard is required.

INSTALLATION NOTES (Ex ia IIC T6... T5 Ga; Ex ia IIIC T100°C Da):

Entity Parameters:
Sensors: $U_i = 22 \text{ VDC}$; $I_i = 120 \text{ mA}$; $P_i = 0.4 \text{ W}$; $C_i = 3 \text{ nF}$; $L_i = 0 \text{ mH}$
Solenoid Junction Terminals: $U_i = 28 \text{ VDC}$; $I_i = 120 \text{ mA}$; $C_i \text{ Junction}^* = 0$; $L_i \text{ Junction}^* = 0$
* Solenoid installation shall meet: $C_a \geq C_i \text{ solenoid} + C_i \text{ Junction} + C_{cable}$; $L_a \geq L_i \text{ solenoid} + L_i \text{ Junction} + L_{cable}$;

- V_{oc} , V_i or $U_o < U_i$; I_{sc} , I_i or $I_o < I_i$; $C_a > C_i + C_{cable}$; $L_a > L_i + L_{cable}$.
- Dust-tight conduit seal must be used when installed in Zone 20, Zone 21, and Zone 22 environments or where Ingress Protection of IP67 is required.
- Control equipment connected to barrier must not use or generate more than 250 Vrms or VDC.
- Installation should be in accordance with appropriate local code or practice.
- The configuration of an associated apparatus for each sensor wiring pair or solenoid wiring pair must be approved.
- Associated apparatus manufacturer's installation drawing must be followed when installing this equipment.
- To maintain intrinsic safety, wiring associated with each sensor or solenoid coil wiring must be run in separate cables or separate shields connected to intrinsically safe (associated apparatus) ground.
- Conduit Grounding - Upon installation verify electrical continuity between conduit and ground terminal.
- Resistance between Intrinsic Safe Ground and earth ground must be less than one ohm.

Specific Conditions of Use:

- Part of the enclosure may be constructed from plastic. To prevent the risk of electrostatic sparking the plastic surface should only be cleaned with a damp cloth.
- The apparatus enclosure may contain aluminum which is considered to constitute a potential risk of ignition by impact or friction. Care must be taken into account during installation and use to prevent impact or friction.

<p>RESTRICTED THIS DRAWING AND ALL INFORMATION CONTAINED HEREIN IS THE PROPERTY OF AND IS SUBJECT TO CHANGE BY STONEL. DRAWING IS NOT TO BE REPRODUCED OR REVEALED TO ANY OTHER PARTY UNLESS AUTHORIZED BY STONEL.</p>		<p>Stonel NELES USA INC., FERGUS FALLS, MN 56537 USA</p>																	
<p>TITLE: I.S. CONTROL, AXIOM, AN/ANX SERIES</p>		<p>DRAWING NO.: 105412</p>																	
<p>SCALE: NS</p>	<p>SHEET: 2 OF 3</p>	<p>REV.:</p>																	
<p>SIZE: A</p>	<p>DATE: 1/14/2016</p>	<p>E</p>																	
<p>DR.: BL</p>	<p>CHK.: RB</p>	<p>APPD.: NK</p>	<p>DIMENSIONS: INCHES (UNLESS OTHERWISE SPECIFIED)</p>																
<p>TOLERANCES* (UNLESS OTHERWISE SPECIFIED): X.XXX ± .005 ANGLES ± 0° 30' X.XX ± .010 FINISH F125 RMS XX ± .015</p>	<p>REVISIONS</p> <table border="1"> <tr> <td>E</td> <td>13982</td> <td>06/16/20</td> <td>RB</td> </tr> <tr> <td>D</td> <td>13940</td> <td>09/11/18</td> <td>RB</td> </tr> <tr> <td>C</td> <td>12685</td> <td>04/10/17</td> <td>RB</td> </tr> <tr> <td>REVISION</td> <td>ECO</td> <td>DATE</td> <td>BY</td> </tr> </table>	E	13982	06/16/20	RB	D	13940	09/11/18	RB	C	12685	04/10/17	RB	REVISION	ECO	DATE	BY	<p>06/16/20</p>	<p>09/11/18</p>
E	13982	06/16/20	RB																
D	13940	09/11/18	RB																
C	12685	04/10/17	RB																
REVISION	ECO	DATE	BY																

8.1 Controlled installation drawings continued

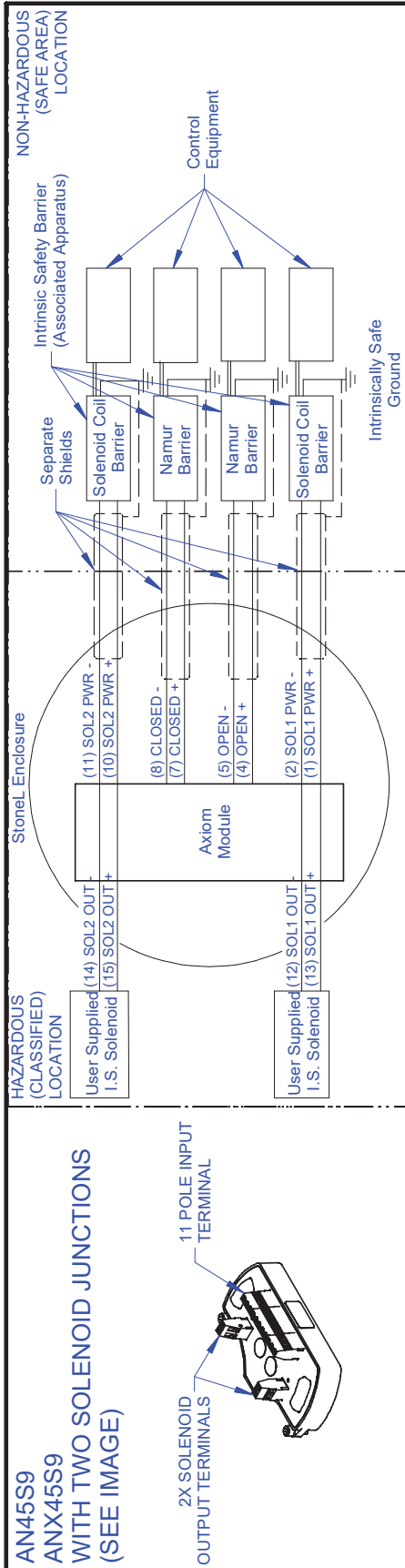

INSTALLATION NOTES (Ex ia IIC T6...T5 Ga; Ex ia IIIC T100°C Da):

Entity Parameters:
Sensors: U_i = 22 VDC; I_i = 120 mA; P_i = 0.4 W; C_i = 3 nF; L_i = 0 mH
Solenoid Junction Terminals: U_i = 28 VDC; I_i = 120 mA; C_{i_junction}* = 0; L_{i_junction}* = 0
 * Solenoid installation shall meet: Ca ≥ C_{i_solenoid} + C_{i_junction} + C_{cable}; La ≥ L_{i_solenoid} + L_{i_junction} + L_{cable};

1. Voc, Vi or Uo < Ui; Isc, It or Io < Ii; Ca > Ci + Ccable; La > Li + Lcable.
2. Dust-tight conduit seal must be used when installed in Zone 20, Zone 21, and Zone 22 environments or where Ingress Protection of IP67 is required.
3. Control equipment connected to barrier must not use or generate more than 250 Vrms or VDC.
4. Installation should be in accordance with appropriate local code or practice.
5. The configuration of associated apparatus for each sensor wiring pair or solenoid wiring pair must be approved.
6. Associated apparatus manufacturer's installation drawing must be followed when installing this equipment.
7. To maintain intrinsic safety, wiring associated with each sensor or solenoid coil wiring must be run in separate cables or separate shields connected to intrinsically safe (associated apparatus) ground.
8. Conduit Grounding - Upon installation verify electrical continuity between conduit and ground terminal.
9. Resistance between Intrinsic Safe Ground and earth ground must be less than one ohm.

Specific Conditions of Use:
 1. Part of the enclosure may be constructed from plastic. To prevent the risk of electrostatic sparking the plastic surface should only be cleaned with a damp cloth.
 2. The apparatus enclosure may contain aluminum which is considered to constitute a potential risk of ignition by impact or friction. Care must be taken into account during installation and use to prevent impact or friction.

INSTALLATION NOTES: (US - Class II, III, Division 1 & 2, Groups A, B, C, D, E, F, G T5; Class I / Zone 0 / AEx ia IIC T5 Ga; Class II, III / Zone 20 / AEx ia IIIC T100°C Da) (Canada - Class II, III, Division 1 & 2, Groups A, B, C, D, E, F, G T5; Class I / Zone 0 / Ex ia IIC T5 Ga; Class II, III / Zone 20 / Ex ia IIIC T100°C Da)

Entity Parameters:
Sensors: U_i(V_{max}) = 22 VDC; I_i(I_{max}) = 120 mA; P_i = 0.4 W; C_i = 3 nF; L_i = 0 H
Solenoid Junction Terminals: U_i(V_{max}) = 28 VDC; I_i(I_{max}) = 120 mA; C_{i_junction}* = 0; L_{i_junction}* = 0
 * Solenoid installation shall meet: Ca ≥ C_{i_solenoid} + C_{i_junction} + C_{cable}; La ≥ L_{i_solenoid} + L_{i_junction} + L_{cable};

1. The Associated Apparatus and I.S. solenoid must be FM Approved.
2. The Entity Concept allows interconnection of intrinsically safe apparatus with associated apparatus when the following is true: Voc, Vi or Uo < Ui (V_{max}); Isc, It or Io < Ii (I_{max}); Ca > Ci + Ccable; La > Li + Lcable.
3. Dust-tight conduit seal must be used when installed in Class II and Class III environments.
4. Control equipment connected to barrier must not use or generate more than 250 Vrms or VDC.
5. Installation should be in accordance with ANSI/ISA RPA12.06.01 "Installation of Intrinsically Safe Systems for Hazardous (Classified) Locations" and the National Electrical Code (ANSI/NFPA 70) or in accordance with the Canadian Electric Code.
6. Associated apparatus manufacturer's installation drawing must be followed when installing this equipment.
7. To maintain intrinsic safety, wiring associated with each sensor or solenoid coil wiring must be run in separate cables or separate shields connected to intrinsically safe (associated apparatus) ground.
8. Conduit Grounding - Upon installation verify electrical continuity between conduit and ground terminal.
9. Resistance between Intrinsic Safe Ground and earth ground must be less than one ohm.

Specific Conditions of Use:
 1. Part of the enclosure is constructed from plastic. To prevent the risk of electrostatic sparking the plastic surface should only be cleaned with a damp cloth.
 2. The apparatus enclosure may contain aluminum which is considered to constitute a potential risk of ignition by impact or friction. Care must be taken into account during installation and use to prevent impact or friction.
 3. For Division 2 installation the "Turck miniFast®" and "euroFast®" male receptacles shall be mated with a Turck minifast and euroFast female cordset and the use of tool secured Turck lokfast® guard is required.

<p>HAZARDOUS (CLASSIFIED) LOCATION</p> <p>User Supplied (14) SOL2 OUT - I.S. Solenoid (15) SOL2 OUT +</p> <p>User Supplied (12) SOL1 OUT - I.S. Solenoid (13) SOL1 OUT +</p>		<p>NON-HAZARDOUS (SAFE AREA) LOCATION</p> <p>Intrinsic Safety Barrier (Associated Apparatus)</p> <p>Control Equipment</p> <p>Intrinsically Safe Ground</p>																	
<p>AN45S9 ANX45S9 WITH TWO SOLENOID JUNCTIONS (SEE IMAGE)</p>																			
<p>2X SOLENOID OUTPUT TERMINALS</p>		<p>11 POLE INPUT TERMINAL</p>																	
<p>INSTALLATION NOTES (Ex ia IIC T6...T5 Ga; Ex ia IIIC T100°C Da):</p> <p>Entity Parameters: Sensors: U_i = 22 VDC; I_i = 120 mA; P_i = 0.4 W; C_i = 3 nF; L_i = 0 mH Solenoid Junction Terminals: U_i = 28 VDC; I_i = 120 mA; C_{i_junction}* = 0; L_{i_junction}* = 0 * Solenoid installation shall meet: Ca ≥ C_{i_solenoid} + C_{i_junction} + C_{cable}; La ≥ L_{i_solenoid} + L_{i_junction} + L_{cable};</p>																			
<p>1. Voc, Vi or Uo < Ui; Isc, It or Io < Ii; Ca > Ci + Ccable; La > Li + Lcable. 2. Dust-tight conduit seal must be used when installed in Zone 20, Zone 21, and Zone 22 environments or where Ingress Protection of IP67 is required. 3. Control equipment connected to barrier must not use or generate more than 250 Vrms or VDC. 4. Installation should be in accordance with appropriate local code or practice. 5. The configuration of associated apparatus for each sensor wiring pair or solenoid wiring pair must be approved. 6. Associated apparatus manufacturer's installation drawing must be followed when installing this equipment. 7. To maintain intrinsic safety, wiring associated with each sensor or solenoid coil wiring must be run in separate cables or separate shields connected to intrinsically safe (associated apparatus) ground. 8. Conduit Grounding - Upon installation verify electrical continuity between conduit and ground terminal. 9. Resistance between Intrinsic Safe Ground and earth ground must be less than one ohm.</p>																			
<p>Specific Conditions of Use: 1. Part of the enclosure may be constructed from plastic. To prevent the risk of electrostatic sparking the plastic surface should only be cleaned with a damp cloth. 2. The apparatus enclosure may contain aluminum which is considered to constitute a potential risk of ignition by impact or friction. Care must be taken into account during installation and use to prevent impact or friction. 3. For Division 2 installation the "Turck miniFast®" and "euroFast®" male receptacles shall be mated with a Turck minifast and euroFast female cordset and the use of tool secured Turck lokfast® guard is required.</p>																			
<p>REVISONS</p> <table border="1"> <tr> <td>E</td> <td>13982</td> <td>06/16/20</td> <td>RB</td> </tr> <tr> <td>D</td> <td>13940</td> <td>09/11/18</td> <td>RB</td> </tr> <tr> <td>C</td> <td>12695</td> <td>04/10/17</td> <td>RB</td> </tr> <tr> <td>REVISION</td> <td>ECO</td> <td>DATE</td> <td>BY</td> </tr> </table>		E	13982	06/16/20	RB	D	13940	09/11/18	RB	C	12695	04/10/17	RB	REVISION	ECO	DATE	BY	<p>TOLERANCES (UNLESS OTHERWISE SPECIFIED): X.XXX ± .005 ANGLES ± 0° 30' X.XX ± .010 FINISH F125 RMS XX ± .015 DIMENSIONS: INCHES (UNLESS OTHERWISE SPECIFIED)</p>	
E	13982	06/16/20	RB																
D	13940	09/11/18	RB																
C	12695	04/10/17	RB																
REVISION	ECO	DATE	BY																
<p>RESTRICTED THIS DRAWING AND ALL INFORMATION CONTAINED HEREIN IS THE PROPERTY OF AND IS SUBJECT TO CHANGE BY STONEL. DRAWING IS NOT TO BE REPRODUCED OR REVEALED TO ANY OTHER PARTY UNLESS AUTHORIZED BY STONEL.</p>																			
<p>Stonel NELES USA INC., FERGUS FALLS, MN 56337 USA</p>		<p>TITLE I.S. CONTROL, AXIOM, AN/ANX SERIES DRAWING NO. 105412 REV. E</p>																	
<p>SCALE NS SIZE A</p>		<p>SHEET 3 OF 3 DATE 1/14/2016</p>																	

Neles

Vanha Porvoontie 229, P.O. Box 304, FI-01301
VANTAA, Finland.
Tel. +358 20 483 150. Fax +358 20 483 151

neles.com

StoneL

26271 US Hwy 59, Fergus Falls, MN 56537 USA.
Tel. +1 218 739 5774.

stonel.com